

**WIBRE**

IP68  
LIGHTING  
**TOOLS**

20  
21

EN

# CONFIGURATION

## LIGHT COLORS



6000K cold white	4500K neutral white	3000K warm white	royal blue	RGB-6000K + cold white	RGB-4500K + neutral white	RGB-3000K + warm white	dynamic white 3000-6000K	2700K extra warm white
The first choice when maximum light intensity is required. Used on stainless steel surfaces and tiles in cold tones such as blue.	In neutral colouring and pleasant to the eye. Used for a variety of surfaces such as white tiles or exposed concrete.	Creating a warm and sophisticated atmosphere. Used for surfaces in natural and earth tones.	Bold blue tone optimally transferred by the water. Emphasizes the element water. Ideal use for blue surfaces.	Dynamic lighting with unlimited possibilities. Providing for millions of colours as well as programmable colour changes. The additional white light colour intensifies the light and also serves as pure white monochrome illumination of the water. Ideal for use in fun pools, hotel pools, various trick fountains and colourful fountains.			Individual, inspiring adjustment of the white tones from cold to warm white. Use in areas of Human Centric Lighting (HCL).	Extremely warm, pleasant colour tone for a relaxed atmosphere of well-being. Used for surfaces in natural and earth tones.

## BEAM ANGLES

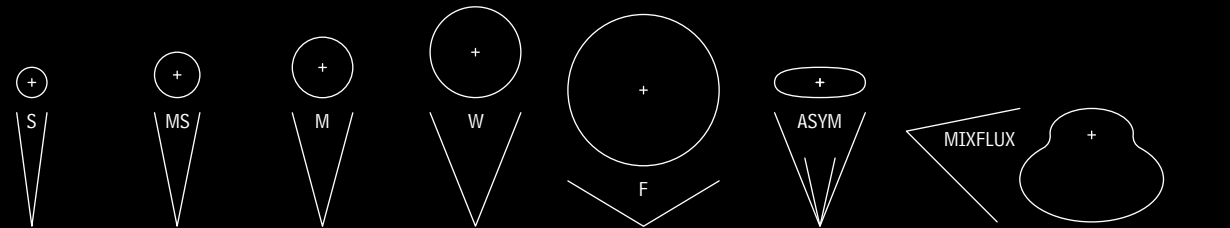

SPOT symmetrical	MEDIUM-SPOT symmetrical	MEDIUM symmetrical	WIDE symmetrical	FLOOD symmetrical	WIDE x SPOT asymmetric	MIXFLUX asymmetric
Emitting a very narrow beam. Providing a bundled, selective lighting.	Emitting a narrow beam. Providing an accentuating effective lighting.	Emitting a compact beam. Providing an individual powerful illumination.	Emitting a wide beam. Providing a wide, extensive illumination.	Emitting a very wide beam. Providing a wide and large-area illumination.	Emitting horizontal beam and narrow vertical beam. Providing a wide, horizontal illumination.	Specially developed light spreading characteristics for swimming pools. Providing a wide, non-glare illumination down to the pool floor.

## ADDITIONAL PARTS



glass disc, frosted

For a softer distribution of light in the water. Resulting in smooth transition from light to shadow (light loss approx. -15%). Used to achieve a more homogeneous illumination of the water.



anti-glare louver

Providing non-glare, directed light. For use in areas with public access.

## POWER SUPPLIES

Detailed technical information on the operating devices can be found in the main catalogue 2019 and at [www.wibre.de](http://www.wibre.de).

## MAIN CATALOGUE

This brochure is solely intended as a supplement to the Main Catalogue 2019, which you can order from us and download at [www.wibre.de](http://www.wibre.de).

## COMPARISON RECESSED SPOTLIGHTS

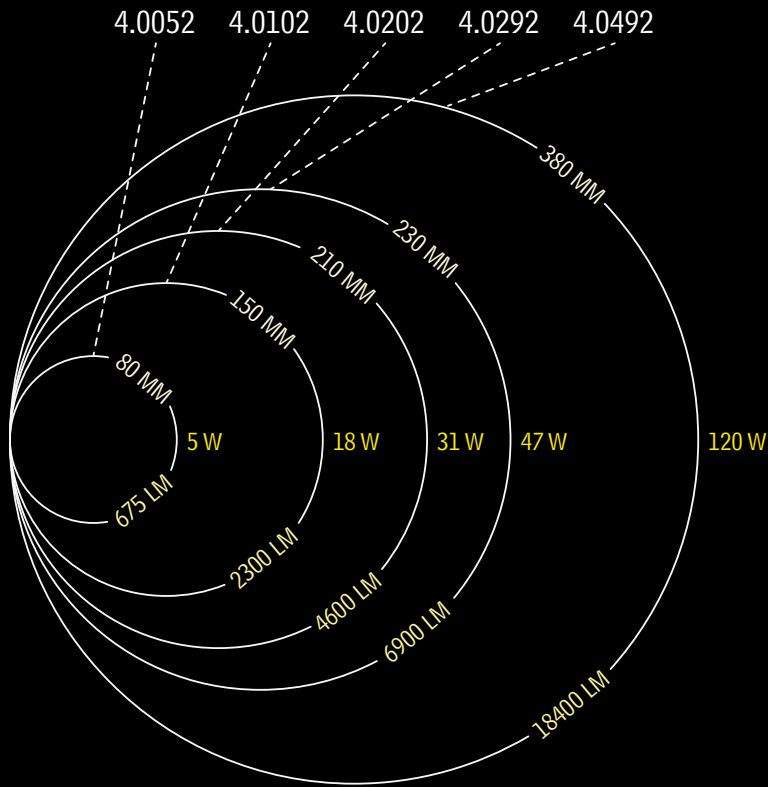

## COMPARISON SURFACE MOUNTED SPOTLIGHTS

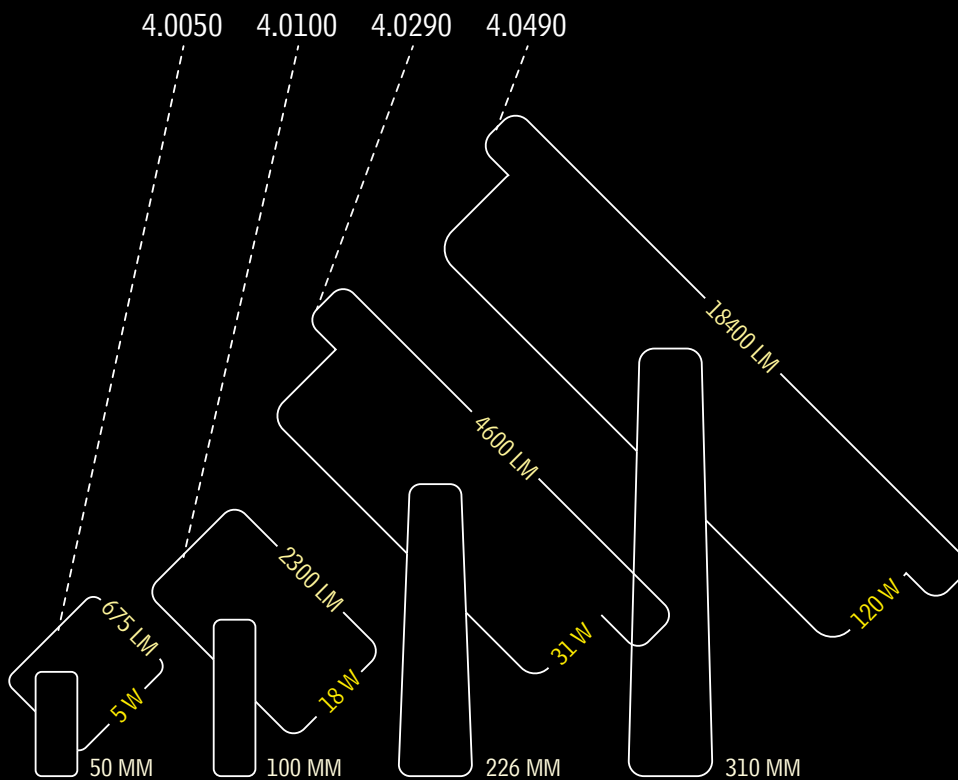





WWW.WIBRE.DE

Imprint:

Publisher: WIBRE Elektrogeräte  
Edmund Breuninger GmbH & Co. KG  
Liebigstr. 9, 74211 Leingarten/Germany  
Phone 07131 9053-0, Fax 07131 9053-19  
Email: [info@wibre.de](mailto:info@wibre.de), Web: [www.wibre.de](http://www.wibre.de)

Edition: W969 Tools 20/21

Photos: WIBRE

Concept, Text and Design: Benjamin Pfendt (WIBRE)

Print: Schweikert Druck, [www.druck-schweikert.de](http://www.druck-schweikert.de)

All information is not binding.

Technical changes reserved.



LIGHT UP YOUR  
POOL AND WATER AREAS 07

LIGHT UP YOUR FOUNTAINS  
AND WATERSIDE ARCHITECTURE 29

RETROFIT YOUR  
OLD SPOTLIGHTS 47

LARC68: HIGHLY RESISTANT  
ARCHITECTURAL LIGHTING 61

THIS IS  
WIBRE 67



LIGHT UP YOUR  
POOL AND WATER AREAS





” UNBELIEVABLE VARIETY AND DESIGN POSSIBILITIES WITH A SMALL SPOTLIGHT.



© THERMEN & BADEWELT SINSHEIM, Germany ▲  
 © Park Hyatt Bangkok; Client: Mosaic Eins; Lighting design: Inverse Lighting Design ▼

## ≈ TYPICAL APPLICATIONS

Individual effect lighting symmetrically as wall installation (recommendation: approximately one light per 1-meter pool length) or randomly placed as starry sky in the pool floor. Atmospheric stairs lighting and accentuation of pool sections are likewise possible.

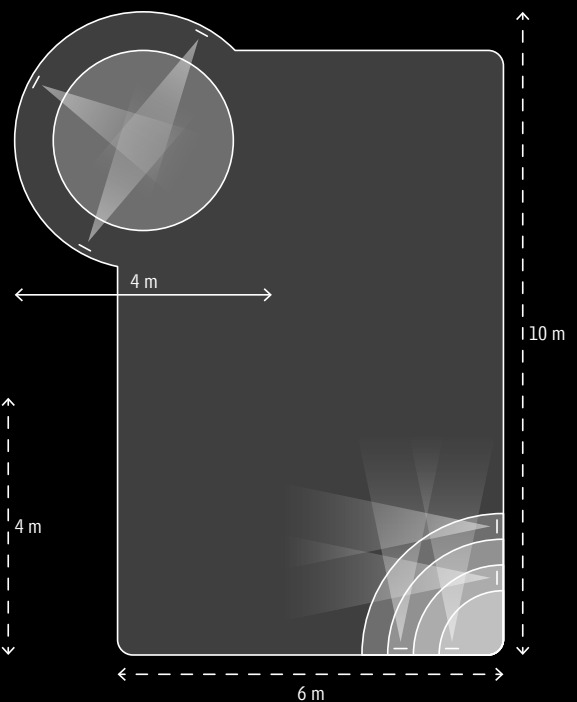
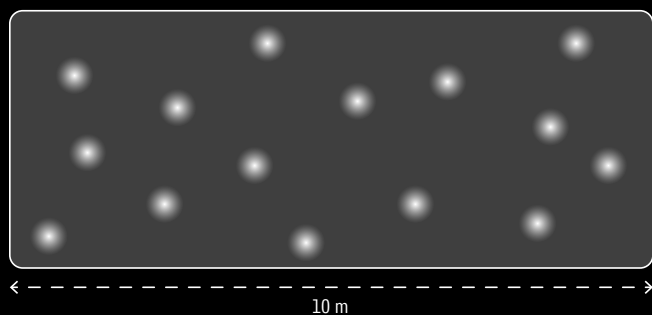
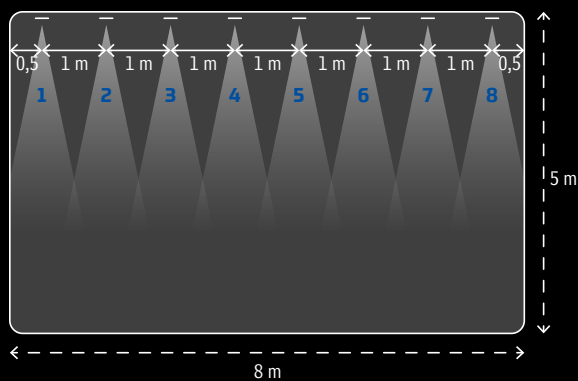

# # 4.0052 RECESSED-SPOTLIGHT

⚡ UP TO 675 LUMEN LIGHT INTENSITY  
PERFECT FOR ACCENTUATION

- ☰ · Protection class IP68 – up to 5m water depth
- Entirely made of stainless steel 316Ti 1.4571
- Round attachment cover, made of stainless steel 316Ti, height 2 mm
- ...
- POW-LED cold white, warm white, neutral white
- Multichip POW-LED RGB-W
- Multichip POW-LED dynamic white
- operating mode: constant current
- Rotationally symmetric light distribution
- ...
- Cable pressure sleeve, stainless steel 316Ti
- Constant-current power source/RGB-W-controller external
- Installation housing made of stainless steel 316Ti with 1.5 m cable protection tube
- Supplied with lamp and 3m of underwater cable



## [+] CONFIGURATION

### LIGHT COLORS



### BEAM ANGLES

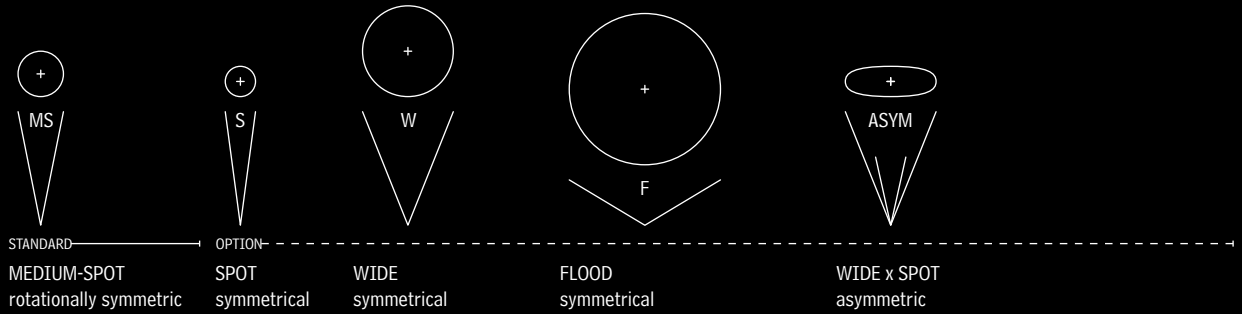

### ADDITIONAL PARTS

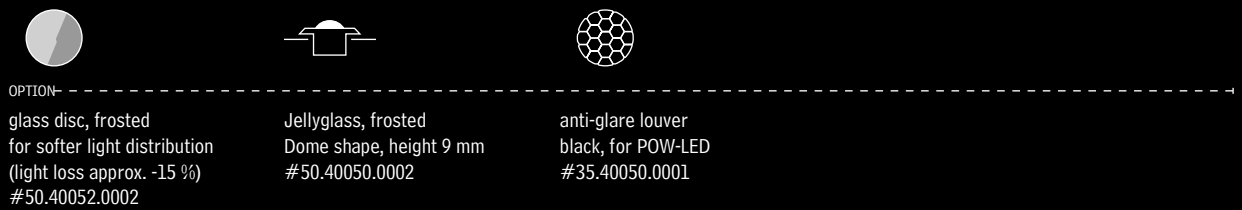

### INSTALLATION TYPES

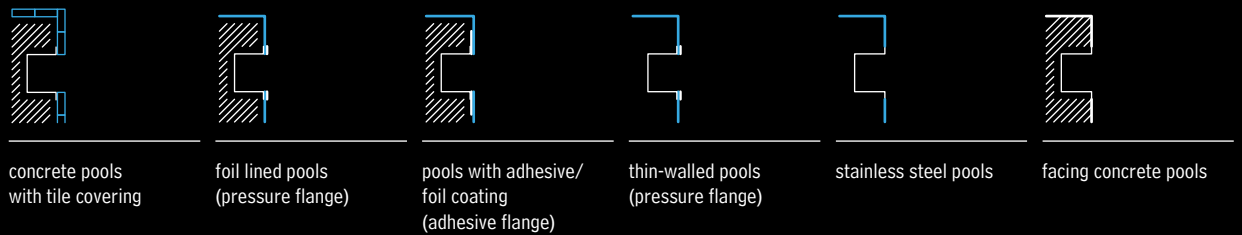

## [+] DIMENSIONS

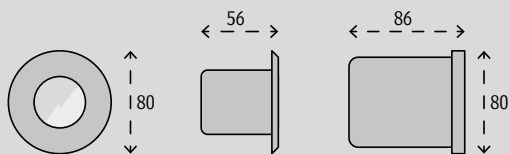



# 4.0052 RECESSED-SPOTLIGHT

IP68	STAINLESS STEEL V4A 1.4571 316Ti	ELECTRO POLISHED	POW-LED INCL.	3.000 K 4.500 K 6.000 K	RGB-W	DYNAMIC WHITE	DALI 1-10V OPTIONAL DIMM	CONSTANT CURRENT KONSTANT STROM	CABLE INCL.	max 5m				CE	
------	--	------------------	---------------	-------------------------------	-------	---------------	-----------------------------	------------------------------------	-------------	--------	--	--	--	----	--



## MONOCHROME ILLUMINATION

#	4.0052.20.11	#	4.0052.20.12	#	4.0052.20.13
COLOR	6.000K cold white	COLOR	3.000K warm white	COLOR	4.500K neutral white
LED	1 POW-LED	LED	1 POW-LED	LED	1 POW-LED
LUMEN	675 lm	LUMEN	540 lm	LUMEN	575 lm
WATT	total 5 W	WATT	total 5 W	WATT	total 5 W
POWER	CC 350mA @12 V-DC	POWER	CC 350mA @12 V-DC	POWER	CC 350mA @12 V-DC
BEAM	25° medium-spot	BEAM	25° medium-spot	BEAM	25° medium-spot
CABLE	UW, 2x0,5 qmm	CABLE	UW, 2x0,5 qmm	CABLE	UW, 2x0,5 qmm
CONNECT	5.0635.65.10 max 1 5.0635.65.20 max 3	CONNECT	5.0635.65.10 max 1 5.0635.65.20 max 3	CONNECT	5.0635.65.10 max 1 5.0635.65.20 max 3

## DYNAMIC ILLUMINATION

#	4.0052.20.41	#	4.0052.20.42	#	4.0052.20.43	#	4.0052.20.80
COLOR	RGB-CW cold white 6000K	COLOR	RGB-WW warm white 3000K	COLOR	RGB-NW neutral white 4500K	COLOR	3000K-6000K dynamic white
LED	1 Multichip POW-LED	LED	1 Multichip POW-LED	LED	1 Multichip POW-LED	LED	1 Multichip POW-LED
LUMEN	cold white: 145 lm	LUMEN	warm white: 125 lm	LUMEN	neutral white: 135 lm	LUMEN	250-290 lm
WATT	all on 4 W	WATT	all on 4 W	WATT	all on 4 W	WATT	all on 4 W
POWER	CC 350mA @12 V-DC	POWER	CC 350mA @12 V-DC	POWER	CC 350mA @12 V-DC	POWER	CC 350mA @12 V-DC
BEAM	25° medium-spot	BEAM	25° medium-spot	BEAM	25° medium-spot	BEAM	25° medium-spot
CABLE	UW, 8x0,25 qmm	CABLE	UW, 8x0,25 qmm	CABLE	UW, 8x0,25 qmm	CABLE	UW, 8x0,25 qmm
CONNECT	5.0635.19.52 max 3 (12V-DC) or 12 (SELV)	CONNECT	5.0635.19.52 max 3 (12V-DC) or 12 (SELV)	CONNECT	5.0635.19.52 max 3 (12V-DC) or 12 (SELV)	CONNECT	5.0635.19.52 max 3 (12V-DC) or 12 (SELV)

## INSTALLATION HOUSINGS

#	4.0052.01.00	#	4.0052.02.00	#	4.0052.03.00	#	4.0052.05.00
	made of V4A stainless steel with 1.5 m protective cable tube and M20 plastic terminating connection, for wall installation, for welding into stainless steel pools and for installation in concrete pools with tile covering (Flange ø 80 mm)		made of V4A stainless steel with 1.5m protective cable tube and M20 plastic terminating connection, for wall installation, for installation in thin-walled pools and foil lined pools (pressure flange ø 84 mm)		made of V4A stainless steel with 1.5 m protective cable tube and M20 plastic terminating connection, for wall installation, for installation in pools with adhesive/foil coating (adhesive flange ø 150 mm)		made of V4A stainless steel with 1.5 m protective cable tube and M20 plastic terminating connection, for installation in the ground up to water depth 1,30 m, for welding into stainless steel pools and for installation in concrete pools with tile covering (Housing depth 110 mm, base plate ø 120 mm with fixing/alignment possibility, flange ø 80 mm)

## USE IN SALT WATER

This spotlight is also available as a salt-water version. Spotlights for salty water (with a saltwater concentration of up to 3.5 %) are made of special V4A stainless steel 904L (1.4539).

” PERFECTION  
IN DESIGN AND  
FUNCTIONALITY -  
WITHOUT  
IFS AND BUTS.



© St. Martins Therme & Lodge; Photo: Alexander Wieseltmair.  
© Paradise City, SPA & Pools, Incheon, Korea; Lighting Designer: EON SLD; Lighting Supplier: S.J.L. Corp.

## ≈ TYPICAL APPLICATIONS

For pools up to 3 or 4 metres wide, choose a single-sided arrangement or offset positioning of the spotlights on both sides. This luminaire allows for individual design - one spotlight is recommended for every 2 metres of pool length. Organically shaped pools show the best effect with an even arrangement.

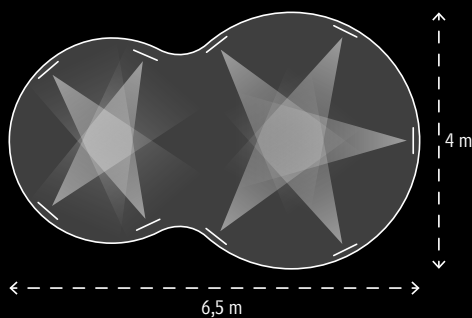
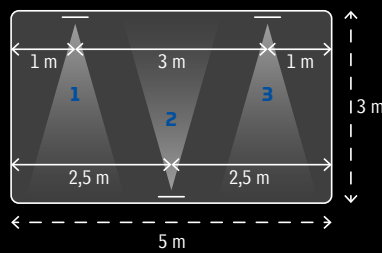
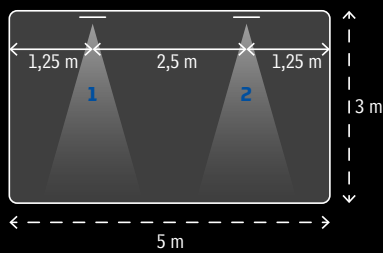

## # 4.0102 RECESSED-SPOTLIGHT

✦ UP TO 2300 LUMEN LIGHT INTENSITY  
IDEAL FOR ORGANIC-SHAPED POOLS AND PRIVATE POOLS

- ☰ · Protection class IP68 – up to 5m water depth
- Entirely made of stainless steel 316Ti 1.4571, epolished
- Round and square attachment cover, made of stainless steel 316Ti, height 2 mm
- ...
- POW-LED cold white, warm white, neutral white
- Multichip POW-LED RGB-W
- Multichip POW-LED dynamic white
- operating mode: constant current
- temperature controlled (onboard)
- surge protection
- Rotationally symmetric light distribution
- ...
- Constant-current power source/RGB-W-controller ordered separately
- Installation housing made of stainless steel 316Ti with 1.5 m cable protection tube
- Supplied with 3 m of special underwater cable

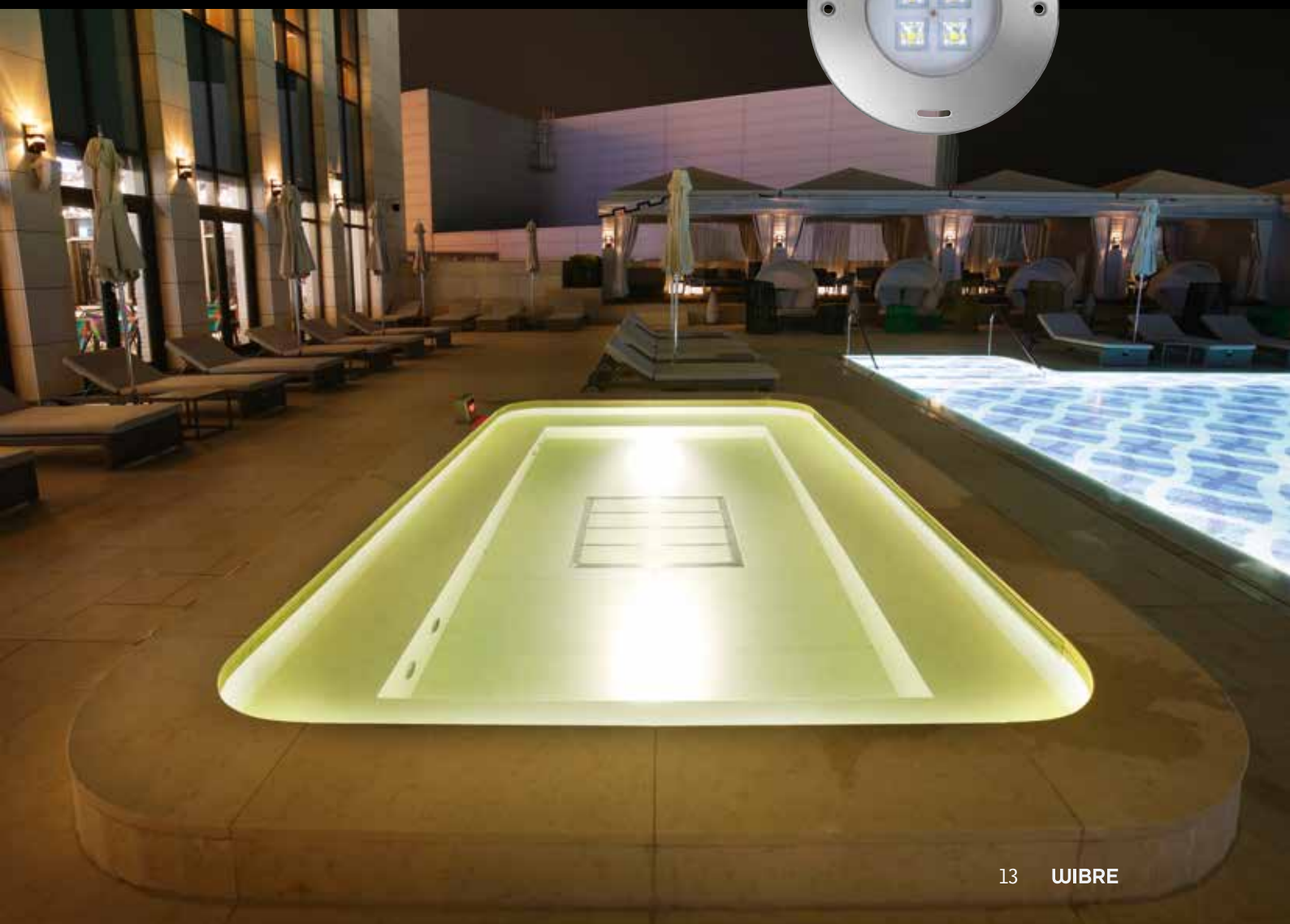



## [+] CONFIGURATION

### LIGHT COLORS



### BEAM ANGLES

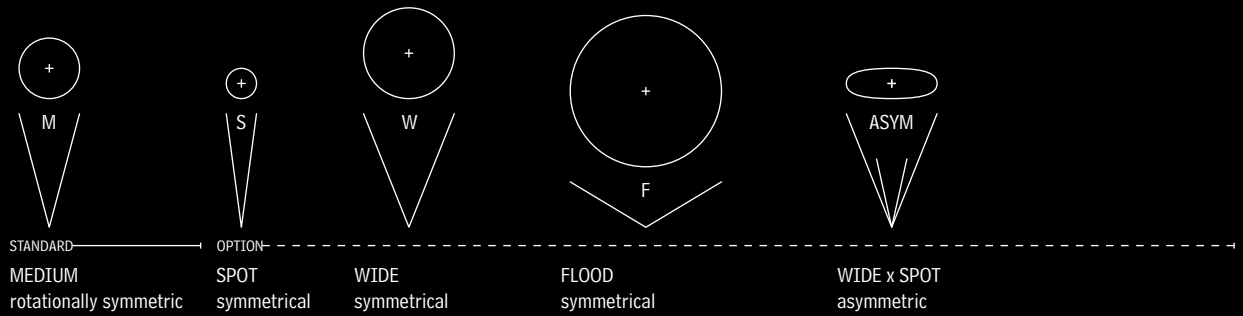

### ADDITIONAL PARTS

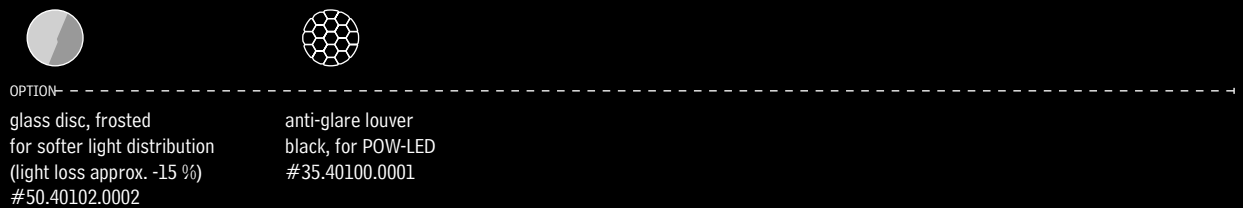

### INSTALLATION TYPES

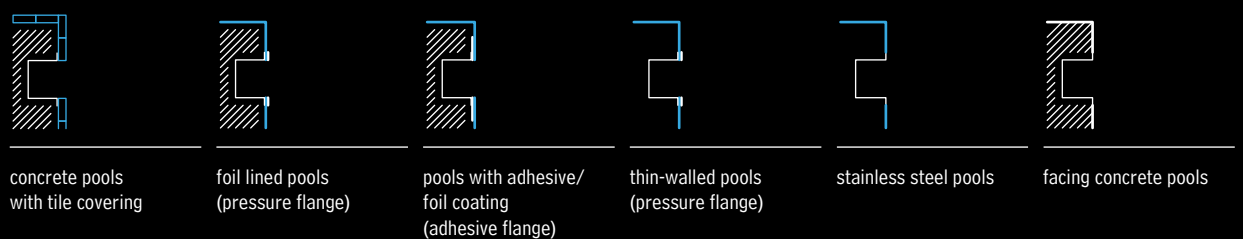

## [+] DIMENSIONS

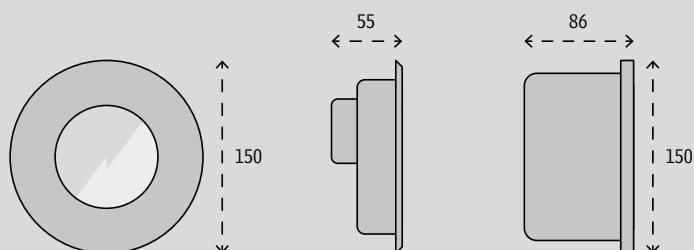

# 4.0102 RECESSED-SPOTLIGHT

IP68	STAINLESS STEEL V4A 1.4571 316Ti	ELECTRO POLISHED	POW-LED INCL.	3.000 K 4.500 K 6.000 K	RGB-W	DYNAMIC WHITE	DALI 1-10V OPTIONAL DIMM	CONSTANT CURRENT KONSTANT STROM	CABLE INCL.	max 5m				CE	
------	--	------------------	---------------	-------------------------------	-------	---------------	-----------------------------	------------------------------------	-------------	--------	--	--	--	----	--

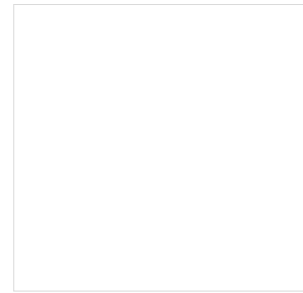

## MONOCHROME ILLUMINATION

#	4.0102.20.11	#	4.0102.20.12	#	4.0102.20.13	#	4.0102.20.16
COLOR	6000K cold white	COLOR	3000K warm white	COLOR	4500K neutral white	COLOR	royal blue (450 nm)
LED	4 POW-LED	LED	4 POW-LED	LED	4 POW-LED	LED	4 POW-LED
LUMEN	2300 lm	LUMEN	1880 lm	LUMEN	2010 lm	LUMEN	500mW/LED
WATT	total 18 W	WATT	total 18 W	WATT	total 18 W	WATT	total 18 W
POWER	CC 1200mA @12 V-DC	POWER	CC 1200mA @12 V-DC	POWER	CC 1200mA @12 V-DC	POWER	CC 1200mA @12 V-DC
BEAM	30° medium	BEAM	30° medium	BEAM	30° medium	BEAM	30° medium
CABLE	UW, 2x1,5 qmm	CABLE	UW, 2x1,5 qmm	CABLE	UW, 2x1,5 qmm	CABLE	UW, 2x1,5 qmm
CONNECT	5.0630.10.04 max 1 5.0630.00.04 max 1 (without mounting housing)	CONNECT	5.0630.10.04 max 1 5.0630.00.04 max 1 (without mounting housing)	CONNECT	5.0630.10.04 max 1 5.0630.00.04 max 1 (without mounting housing)	CONNECT	5.0630.10.04 max 1 5.0630.00.04 max 1 (without mounting housing)

## DYNAMIC ILLUMINATION

#	4.0102.20.41	#	4.0102.20.42	#	4.0102.20.43	#	4.0102.20.80
COLOR	RGB-CW cold white 6000K	COLOR	RGB-WW warm white 3000K	COLOR	RGB-NW neutral white 4500K	COLOR	3000K-6000K dynamic white
LED	4 Multichip POW-LED	LED	4 Multichip POW-LED	LED	4 Multichip POW-LED	LED	4 Multichip POW-LED
LUMEN	cold white: 580 lm	LUMEN	warm white: 500 lm	LUMEN	neutral white: 540 lm	LUMEN	1000-1160 lm
WATT	all on 17 W	WATT	all on 17 W	WATT	all on 17 W	WATT	all on 17 W
POWER	CC 350mA @12 V-DC	POWER	CC 350mA @12 V-DC	POWER	CC 350mA @12 V-DC	POWER	CC 350mA @12 V-DC
BEAM	30° medium	BEAM	30° medium	BEAM	30° medium	BEAM	30° medium
CABLE	UW, 8x0,25 qmm	CABLE	UW, 8x0,25 qmm	CABLE	UW, 8x0,25 qmm	CABLE	UW, 8x0,25 qmm
CONNECT	5.0635.19.52 max 1 (12V-DC) or 3 (SELV)	CONNECT	5.0635.19.52 max 1 (12V-DC) or 3 (SELV)	CONNECT	5.0635.19.52 max 1 (12V-DC) or 3 (SELV)	CONNECT	5.0635.19.52 max 1 (12V-DC) or 3 (SELV)

## INSTALLATION HOUSINGS

#	4.0102.01.00	#	4.0102.02.00	#	4.0102.02.40	#	4.0102.03.00
	for round and squared cover, made of V4A stainless steel with 1.5 m protective cable tube and M20 plastic terminating connection, for welding into stainless steel pools and for installation in concrete pools with tile covering		for round cover, made of V4A stainless steel with 1.5m protective cable tube and M20 plastic terminating connection, for installation in thin-walled pools and foil lined pools (pressure flange ø 155 mm)		for squared cover, made of V4A stainless steel with 1.5m protective cable tube and M20 plastic terminating connection, for installation in thin-walled pools and foil lined pools (pressure flange 155 x 155 mm)		for round and squared cover, made of V4A stainless steel with 1.5 m protective cable tube and M20 plastic terminating connection, for installation in pools with adhesive/foil coating (adhesive flange ø 250 mm)

## USE IN SALT WATER

This spotlight is also available as a salt-water version. Spotlights for salty water (with a saltwater concentration of up to 3.5 %) are made of special V4A stainless steel 904L (1.4539).

” COMPACT,  
EFFECTIVE,  
POWERFUL.  
THE ALL-ROUNDER  
FOR POOL LIGHTING.



© WERK12, Munich, Germany; Architect: MVRDV; Images: Ossip van Duijvenbode  
Copyright: MVRDV 2018 – (Winy Maas, Jacob van Rijs, Nathalie de Vries) ▲  
© Alpin Panorama Hotel Hubertus, Bozen, Italy; Client: Herokal, Bozen; Photo: Alex Filz ▼

## ≈ TYPICAL APPLICATIONS

For pools in standard sizes up to 5 metres wide, choose a single-sided arrangement or offset positioning of the spotlights on both sides. The number of spotlights depends on the pool length - one spotlight per 2 to 3 metres is recommended.

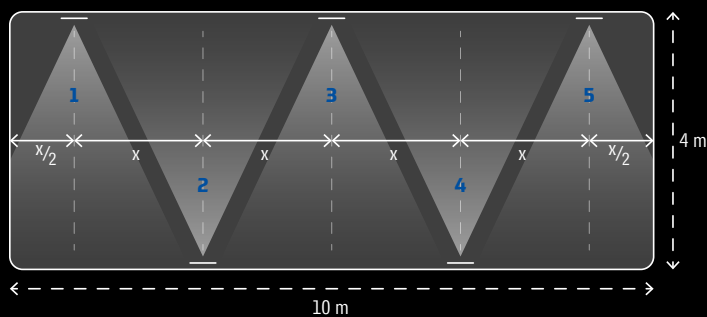
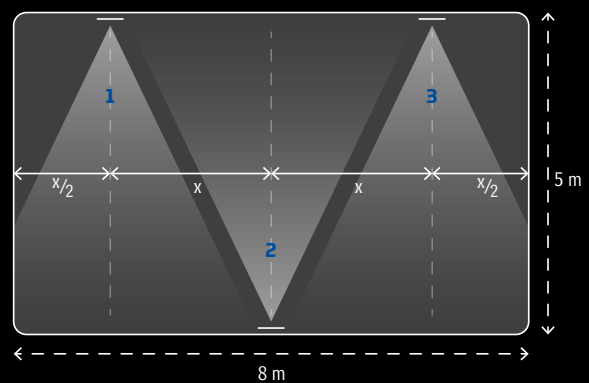
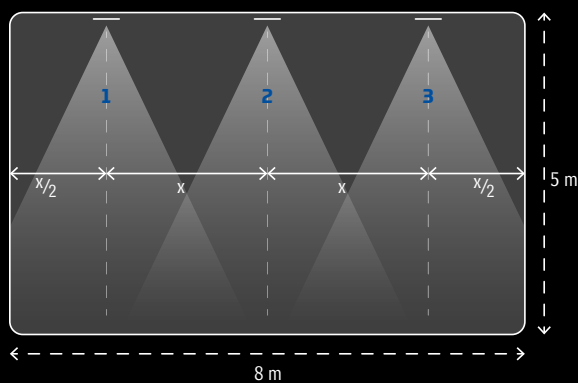



# # 4.0202 SWIMMINGPOOL-LIGHT

⚡ UP TO 4600 LUMEN LIGHT INTENSITY  
IDEAL FOR HOTEL POOLS AND PRIVATE POOLS

- ☰ · Protection class IP68 – up to 5m water depth
- Entirely made of stainless steel 316Ti 1.4571, polished
- Round attachment cover, made of stainless steel 316Ti, height 2 mm
- ...
- POW-LED cold white, warm white, neutral white
- POW-LED royal blue
- Multichip POW-LED RGB-W
- operating mode: constant current
- temperature controlled (onboard)
- surge protection
- rotationally symmetric wide light distribution
- ...
- Constant-current power source/RGB-W-controller ordered separately
- Installation housing made of stainless steel 316Ti with 1.5 m cable protection tube
- Supplied with 5 m of special underwater cable



[+] CONFIGURATION

LIGHT COLORS



BEAM ANGLES

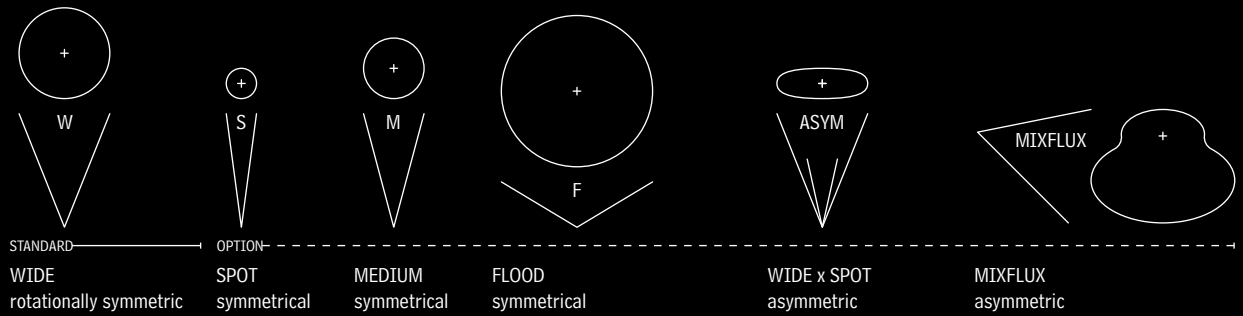

ADDITIONAL PARTS



OPTION  
 glass disc, frosted  
 for softer light distribution  
 (light loss approx. -15 %)  
 #50.40202.0002

INSTALLATION TYPES

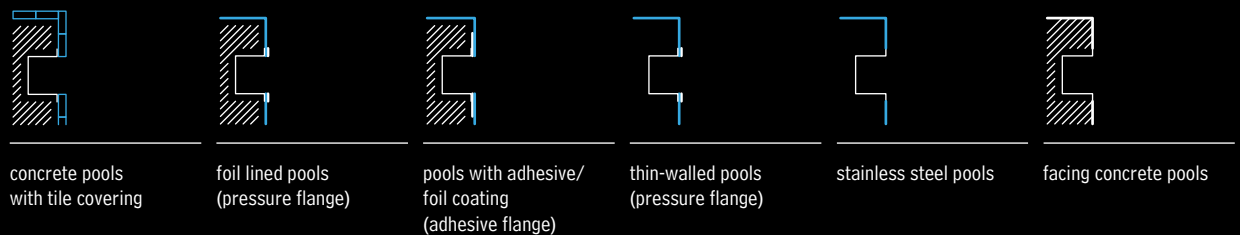

[+] DIMENSIONS

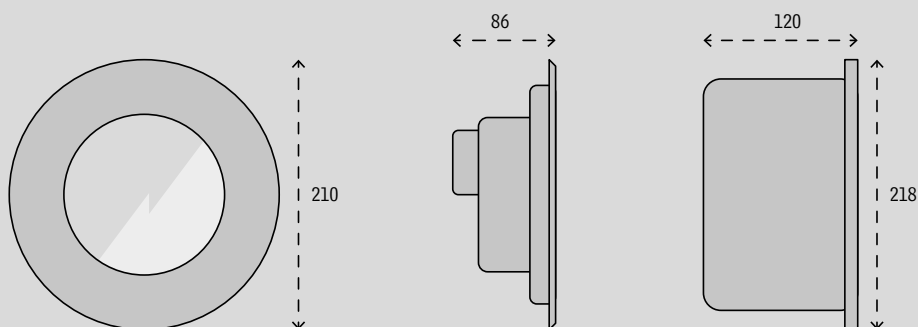

# 4.0202 SWIMMINGPOOL-LIGHT

IP68	STAINLESS STEEL V4A 1.4571 316Ti	POW-LED INCL.	3.000 K 4.500 K 6.000 K BLUE	RGB-W	CONSTANT CURRENT KONSTANT STROM	DALI 1-10 V OPTIONAL DIMM	CABLE INCL.	max 5m			CE	
------	--	---------------	---------------------------------------	-------	------------------------------------	------------------------------	-------------	--------	--	--	----	--



## MONOCHROME ILLUMINATION

#	4.0202.00.11	#	4.0202.00.12	#	4.0202.00.13	#	4.0202.00.16
COLOR	6.000K cold white	COLOR	3.000K warm white	COLOR	4.500K neutral white	COLOR	royal blue (450 nm)
LED	8 POW-LED	LED	8 POW-LED	LED	8 POW-LED	LED	8 POW-LED
LUMEN	4600 lm	LUMEN	3760 lm	LUMEN	4024 lm	LUMEN	500mW/LED
WATT	total 31 W	WATT	total 31 W	WATT	total 31 W	WATT	total 33 W
POWER	CC 2400mA @12 V-DC	POWER	CC 2400mA @12 V-DC	POWER	CC 2400mA @12 V-DC	POWER	CC 2400mA @12 V-DC
BEAM	50° symmetrisch	BEAM	50° symmetrisch	BEAM	50° symmetrisch	BEAM	50° symmetrisch
CABLE	UW, 2x2,5 qmm	CABLE	UW, 2x2,5 qmm	CABLE	UW, 2x2,5 qmm	CABLE	UW, 2x2,5 qmm
CONNECT	5.0630.10.08 max 1	CONNECT	5.0630.10.08 max 1	CONNECT	5.0630.10.08 max 1	CONNECT	5.0630.10.08 max 1

## DYNAMIC ILLUMINATION

#	4.0202.00.41	#	4.0202.00.42	#	4.0202.00.43	#	4.0202.00.80
COLOR	RGB-CW cold white 6000K	COLOR	RGB-WW warm white 3000K	COLOR	RGB-NW neutral white 4500K	COLOR	3000K-6000K dynamic white
LED	8 Multichip POW-LED	LED	8 Multichip POW-LED	LED	8 Multichip POW-LED	LED	8 Multichip POW-LED
LUMEN	cold white: 1160 lm	LUMEN	warm white: 1000 lm	LUMEN	neutral white: 1080 lm	LUMEN	2000-2320 lm
WATT	all on 50 W	WATT	all on 50 W	WATT	all on 50 W	WATT	all on 50 W
POWER	CC 700mA @12 V-DC	POWER	CC 700mA @12 V-DC	POWER	CC 700mA @12 V-DC	POWER	CC 700mA @12 V-DC
BEAM	50° symmetrisch	BEAM	50° symmetrisch	BEAM	50° symmetrisch	BEAM	50° symmetrisch
CABLE	UW, 10x0,5 qmm	CABLE	UW, 10x0,5 qmm	CABLE	UW, 10x0,5 qmm	CABLE	UW, 10x0,5 qmm
CONNECT	5.0670.19.52 max 1	CONNECT	5.0670.19.52 max 1	CONNECT	5.0670.19.52 max 1	CONNECT	5.0670.19.52 max 1

## INSTALLATION HOUSINGS

#	4.0199.01.00	#	4.0199.02.00	#	4.0199.03.00	#	4.0199.04.00
	made of V4A stainless steel with 1.5 m protective cable tube and M20 plastic terminating connection, for installation in concrete pools with tile covering		made of V4A stainless steel with 1.5 m protective cable tube and M20 plastic terminating connection, for installation in thin-walled pools and foil lined pools (pressure flange ø 218 mm)		made of V4A stainless steel with 1.5 m protective cable tube and M20 plastic terminating connection, for installation in pools with adhesive/foil coating (adhesive flange ø 360 mm)		made of V4A stainless steel with 1.5 m protective cable tube and M20 plastic terminating connection, for facing concrete and for welding into stainless steel pools

” THE BESTSELLER FOR GENERATIONS. THE ULTIMATE IN PERFORMANCE AND QUALITY.



© Bürgenstock Hotels AG; Lichtplaner: Licht Kunst Licht AG, Berlin/Bonn, [www.lichtkunstlicht.com](http://www.lichtkunstlicht.com) ▲  
© Disneyland® Paris, Hotel New York, France; © Disney; Partner: MW MarvalWay ▼

## ≈ TYPICAL APPLICATIONS

Starting from a pool width of 8 metres, choose an opposite arrangement of the spotlights, with a distance of approximately 3 metres between each. This determines the number of spotlights per pool length. The positioning can be parallel or offset. For narrower pools, a one-sided arrangement is practical.

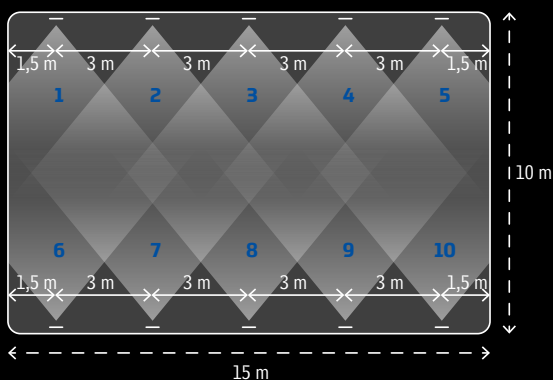
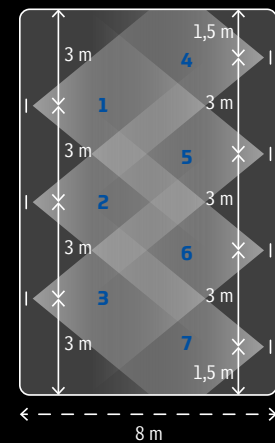
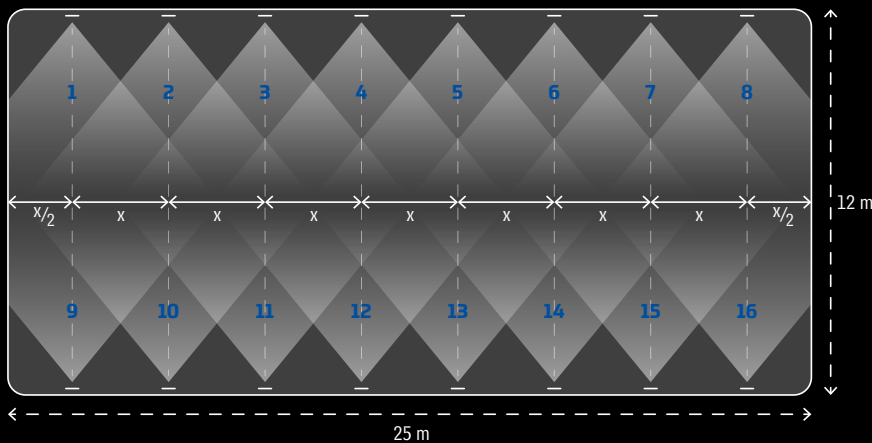



# # 4.0292 SWIMMINGPOOL-LIGHT

UP TO 6900 LUMEN LIGHT INTENSITY  
IDEAL FOR HOTEL POOLS AND PUBLIC POOLS

- Protection class IP68 – up to 5m water depth
- Entirely made of stainless steel 316Ti 1.4571, epolished
- Round attachment cover, made of stainless steel 316Ti, height 2 mm
- ...
- POW-LED cold white, warm white, neutral white
- POW-LED royal blue
- Multichip POW-LED RGB-W
- operating mode: constant current
- temperature controlled (onboard)
- surge protection
- light distribution especially for swimming pool lighting "asymmetric Mixflux"
- ...
- Constant-current power source/RGB-W-controller ordered separately
- Installation housing made of stainless steel 316Ti with 1.5 m cable protection tube
- Supplied with 5 m of special underwater cable





[+] CONFIGURATION

LIGHT COLORS



BEAM ANGLES

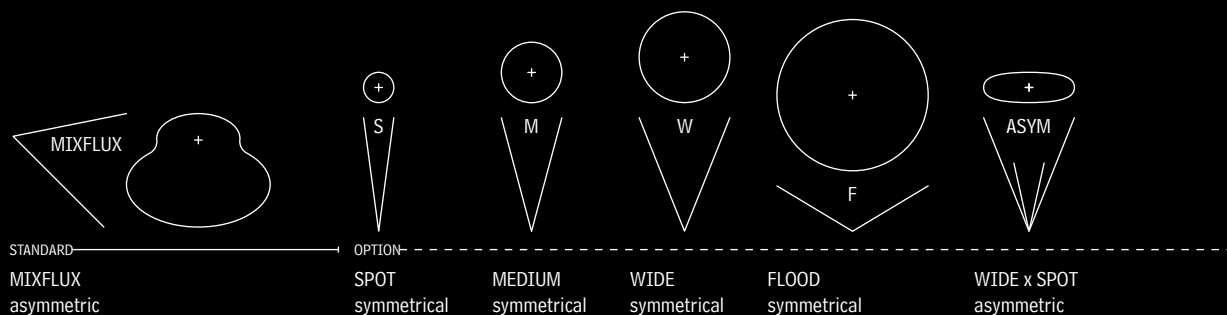

ADDITIONAL PARTS



OPTION  
 glass disc, frosted  
 for softer light distribution  
 (light loss approx. -15 %)  
 #50.40292.0004

INSTALLATION TYPES

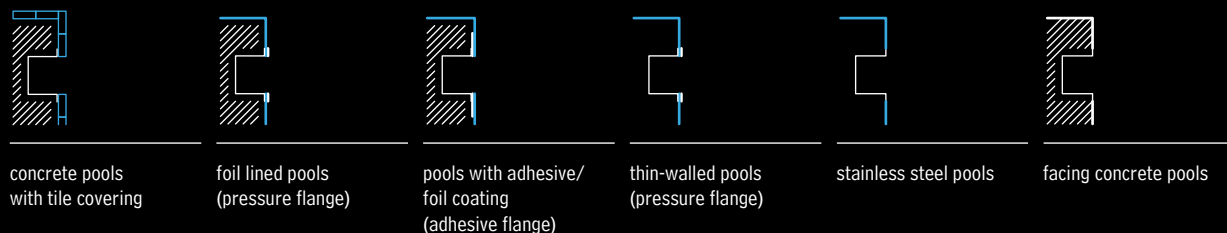

DIMENSIONS

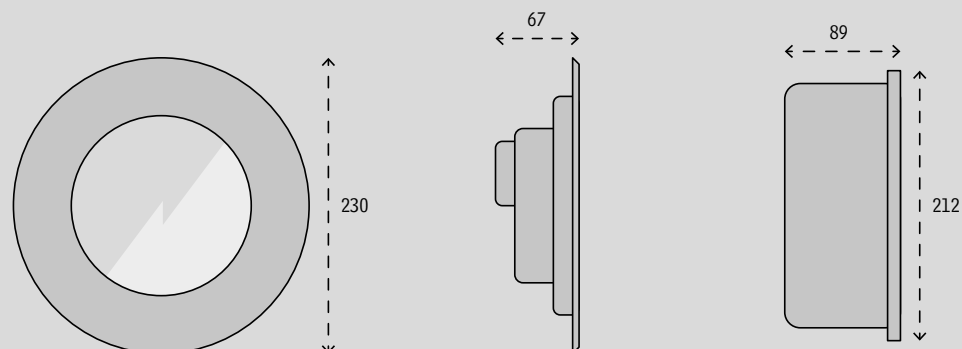

# 4.0292 SWIMMINGPOOL-LIGHT

IP68	STAINLESS STEEL V4A 1.4571 316Ti	POW-LED INCL.	3.000 K 4.500 K 6.000 K BLUE	RGB-W	CONSTANT CURRENT KONSTANT STROM	DALI 1-10 V OPTIONAL DIMM	CABLE INCL.	max 5m			CE	III
------	--	---------------	---------------------------------------	-------	------------------------------------	------------------------------	-------------	--------	--	--	----	-----



## MONOCHROME ILLUMINATION

#	4.0292.00.11	#	4.0292.00.12	#	4.0292.00.13	#	4.0292.00.16
COLOR	6000K cold white	COLOR	3000K warm white	COLOR	4500K neutral white	COLOR	royal blue (450 nm)
LED	12 POW-LED	LED	12 POW-LED	LED	12 POW-LED	LED	48 POW-LED
LUMEN	6900 lm	LUMEN	5640 lm	LUMEN	6036 lm	LUMEN	500mW/LED
WATT	total 47 W	WATT	total 47 W	WATT	total 47 W	WATT	total 49,5 W
POWER	CC 3600mA @12 V-DC	POWER	CC 3600mA @12 V-DC	POWER	CC 3600mA @12 V-DC	POWER	CC 3600mA @12 V-DC
BEAM	asymmetrisch Mixflux	BEAM	asymmetrisch Mixflux	BEAM	asymmetrisch Mixflux	BEAM	asymmetrisch Mixflux
CABLE	UW, 2x2,5 qmm	CABLE	UW, 2x2,5 qmm	CABLE	UW, 2x2,5 qmm	CABLE	UW, 2x2,5 qmm
CONNECT	5.0630.01.12 max 1 5.0630.03.12 max 3	CONNECT	5.0630.01.12 max 1 5.0630.03.12 max 3	CONNECT	5.0630.01.12 max 1 5.0630.03.12 max 3	CONNECT	5.0630.01.12 max 1 5.0630.03.12 max 3

## DYNAMIC ILLUMINATION

#	4.0292.00.41	#	4.0292.00.42	#	4.0292.00.43
COLOR	RGB-CW cold white 6000K	COLOR	RGB-WW warm white 3000K	COLOR	RGB-NW neutral white 4500K
LED	12 Multichip POW-LED	LED	12 Multichip POW-LED	LED	12 Multichip POW-LED
LUMEN	cold white: 2100 lm	LUMEN	warm white: 1800 lm	LUMEN	neutral white: 1920 lm
WATT	all on 75 W	WATT	all on 75 W	WATT	all on 75 W
POWER	CC 1400mA @12 V-DC	POWER	CC 1400mA @12 V-DC	POWER	CC 1400mA @12 V-DC
BEAM	asymmetrisch Mixflux	BEAM	asymmetrisch Mixflux	BEAM	asymmetrisch Mixflux
CABLE	UW, 1x4,0 + 4x1,0 + 2x0,25 qmm	CABLE	UW, 1x4,0 + 4x1,0 + 2x0,25 qmm	CABLE	UW, 1x4,0 + 4x1,0 + 2x0,25 qmm
CONNECT	5.0630.09.52 max 1	CONNECT	5.0630.09.52 max 1	CONNECT	5.0630.09.52 max 1

## INSTALLATION HOUSINGS

#	4.0292.01.00	#	4.0292.02.00	#	4.0292.03.00
	made of V4A stainless steel with 1.5 m protective cable tube and M20 plastic terminating connection, for welding into stainless steel pools and for installation in concrete pools with tile covering		made of V4A stainless steel with 1.5m protective cable tube and M20 plastic terminating connection, for installation in thin-walled pools and foil lined pools (pressure flange ø 244 mm)		made of V4A stainless steel with 1.5 m protective cable tube and M20 plastic terminating connection, for installation in pools with adhesive/foil coating (adhesive flange ø 350 mm)

## USE IN SALT WATER

This spotlight is also available as a salt-water version. Spotlights for salty water (with a saltwater concentration of up to 3.5 %) are made of special V4A stainless steel 904L (1.4539).

” PEAK PERFORMANCE FOR HIGH PERFORMANCES. A POWER-PACK - AS SIMPLE AS NEVER BEFORE.



© Roland Matthes Schwimmhalle, Erfurt, Germany; Photo: Wolfgang Fallier ▲  
© Campus Sursee, Switzerland; Photo: Samuel Trümpy ▼

## ≈ TYPICAL APPLICATIONS

With a distance of about 4 metres each, you choose an opposite parallel arrangement to illuminate competition pools optimally - 12 spotlights per pool length are recommended here. For sports pools with a size of 25 x 12 metres, 5 to 6 spotlights per side are intended. The positioning can also be done in a diagonally offset way.

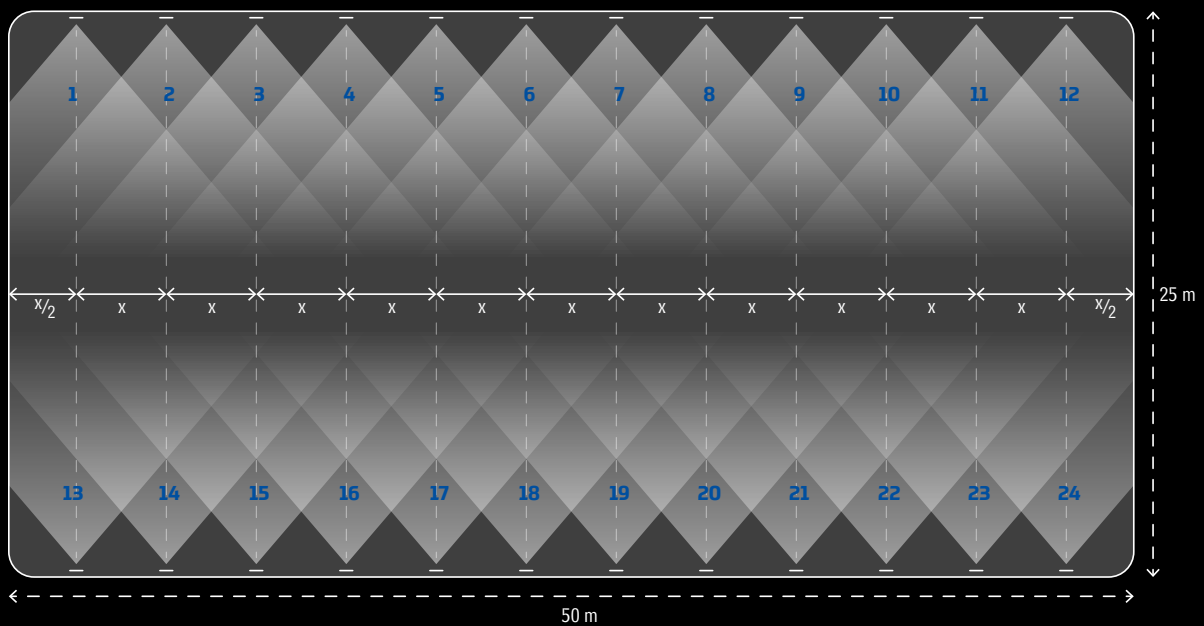

# # 4.0492 SWIMMINGPOOL-LIGHT

UP TO 18600 LUMEN LIGHT INTENSITY  
IDEAL FOR COMPETITION AND SPORT POOLS

- Protection class IP68 – up to 5m water depth
- Entirely made of stainless steel 316Ti 1.4571, epolished
- Round attachment cover, made of stainless steel 316Ti, height 2 mm
- ...
- POW-LED cold white, warm white, neutral white
- POW-LED royal blue
- Multichip POW-LED RGB-W
- operating mode: constant current
- temperature controlled (onboard)
- surge protection
- light distribution especially for swimming pool lighting "asymmetric Mixflux"
- ...
- Constant-current power source/RGB-W-controller ordered separately
- Installation housing made of stainless steel 316Ti with 1.5 m cable protection tube
- Supplied with 5 m of special underwater cable

NEW

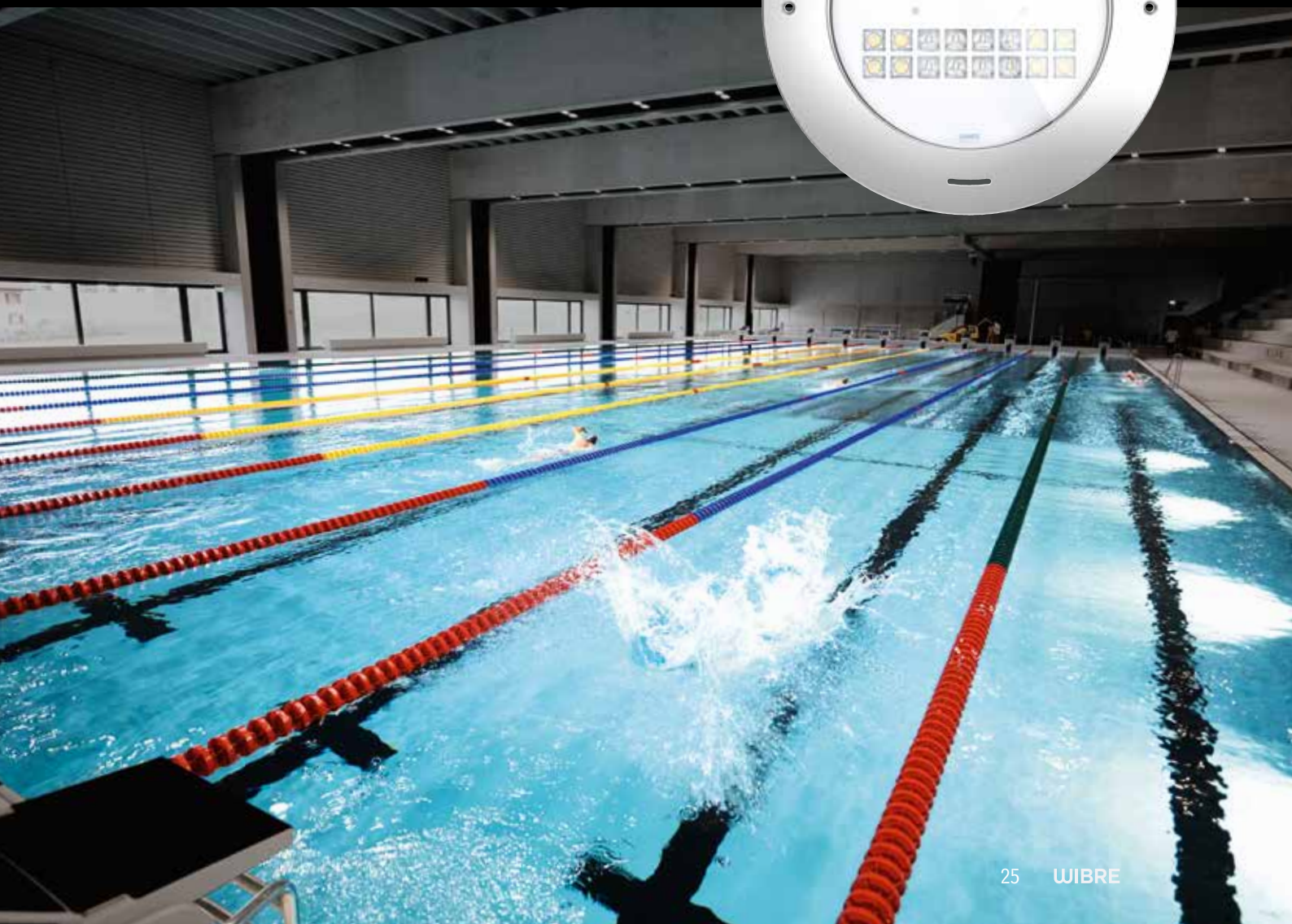

[+] CONFIGURATION

LIGHT COLORS



STANDARD

6000K cold white    4500K neutral white    3000K warm white    RGB-6000K + cold white    RGB-4500K + neutral white    RGB-3000K + warm white

BEAM ANGLES

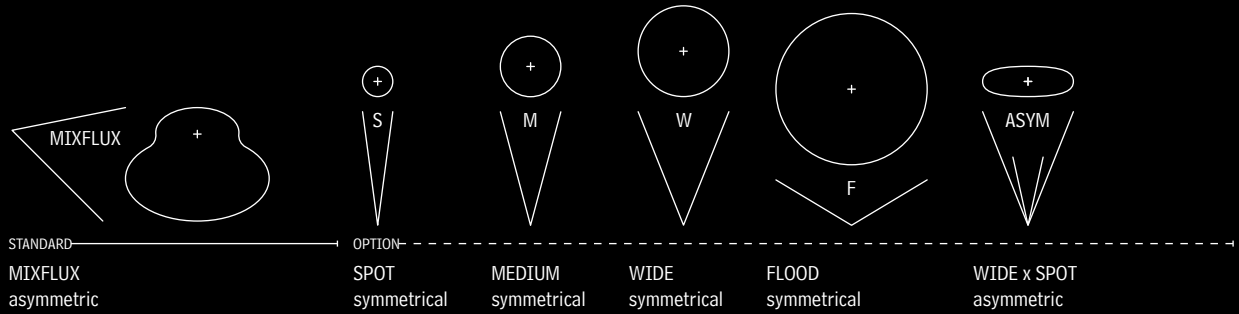

ADDITIONAL PARTS



OPTION

glass disc, frosted  
for softer light distribution  
(light loss approx. -15 %)

INSTALLATION TYPES



concrete pools  
with tile covering



foil lined pools  
(pressure flange)



pools with adhesive/  
foil coating  
(adhesive flange)



thin-walled pools  
(pressure flange)



stainless steel pools



facing concrete pools

▣ DIMENSIONS

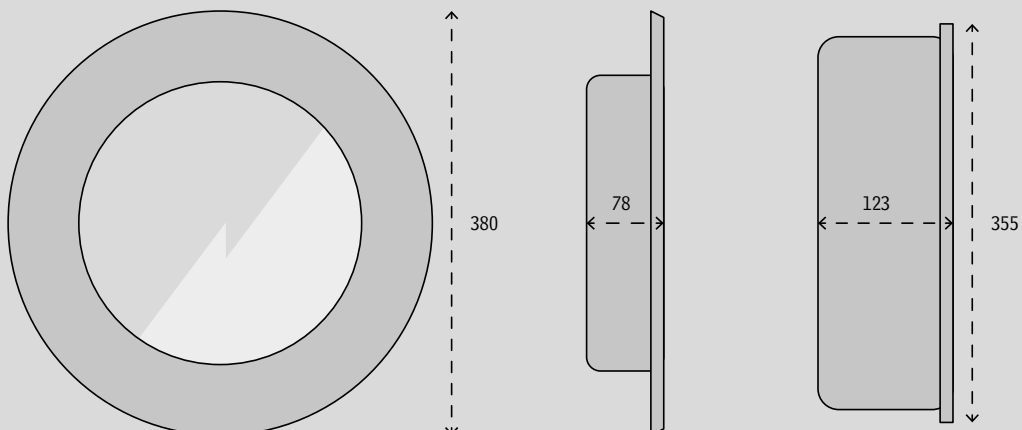



# 4.0492 SWIMMINGPOOL-LIGHT

IP68	STAINLESS STEEL V4A 1.4571 316Ti	POW-LED INCL.	3.000 K 4.500 K 6.000 K BLUE	RGB-W	CONSTANT CURRENT CONSTANT VOLTAGE	DALI 1-10 V OPTIONAL DIMM	CABLE INCL.	max 5m	←	↙	CE	III
------	--	---------------	---------------------------------------	-------	--------------------------------------	------------------------------	-------------	--------	---	---	----	-----

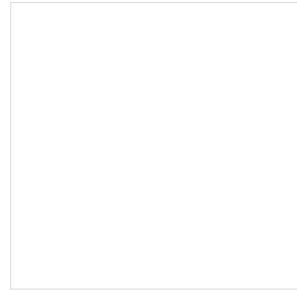
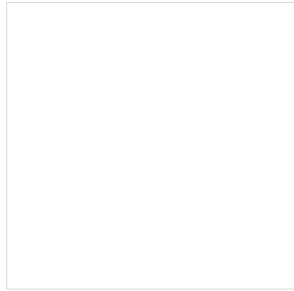

## MONOCHROME ILLUMINATION

#	4.0492.00.11	#	4.0492.00.12	#	4.0492.00.13
COLOR	6000K cold white	COLOR	3000K warm white	COLOR	4500K neutral white
LED	32 POW-LED	LED	32 POW-LED	LED	32 POW-LED
LUMEN	18600 lm	LUMEN	15040 lm	LUMEN	16080 lm
WATT	total 120 W	WATT	total 120 W	WATT	total 120 W
POWER	CV 12 V-DC	POWER	CV 12 V-DC	POWER	CV 12 V-DC
BEAM	asymmetrisch Mixflux	BEAM	asymmetrisch Mixflux	BEAM	asymmetrisch Mixflux
CABLE	UW, 5x1,5 qmm	CABLE	UW, 5x1,5 qmm	CABLE	UW, 5x1,5 qmm
CONNECT	5.0630.10.32 max 1	CONNECT	5.0630.10.32 max 1	CONNECT	5.0630.10.32 max 1

## DYNAMIC ILLUMINATION

#	4.0492.00.41	#	4.0492.00.42	#	4.0492.00.43
COLOR	RGB-CW cold white 6000K	COLOR	RGB-WW warm white 3000K	COLOR	RGB-NW neutral white 4500K
LED	32 Multichip POW-LED	LED	32 Multichip POW-LED	LED	32 Multichip POW-LED
LUMEN	cold white: 4640 lm	LUMEN	warm white: 3760 lm	LUMEN	neutral white: 4020 lm
WATT	all on 140 W	WATT	all on 140 W	WATT	all on 140 W
POWER	CC 12 V-DC	POWER	CC 12 V-DC	POWER	CC 12 V-DC
BEAM	asymmetrisch Mixflux	BEAM	asymmetrisch Mixflux	BEAM	asymmetrisch Mixflux
CABLE	UW, 41x0,5 qmm	CABLE	UW, 41x0,5 qmm	CABLE	UW, 41x0,5 qmm
CONNECT	5.0670.49.52 max 1	CONNECT	5.0670.49.52 max 1	CONNECT	5.0670.49.52 max 1

## INSTALLATION HOUSINGS

#	4.0492.01.00	#	4.0492.02.00	#	4.0492.03.00
	made of V4A stainless steel with 1.5 m protective cable tube and M20 plastic terminating connection, for welding into stainless steel pools and for installation in concrete pools with tile covering		made of V4A stainless steel with 1.5 m protective cable tube and M20 plastic terminating connection, for installation in thin-walled pools and foil lined pools (pressure flange mm)		made of V4A stainless steel with 1.5 m protective cable tube and M20 plastic terminating connection, for installation in pools with adhesive/foil coating (adhesive flange mm)



← LIGHT UP YOUR  
POOL AND WATER AREAS

LIGHT UP YOUR FOUNTAINS  
AND WATERSIDE ARCHITECTURE



” LIGHT TO THE POINT.  
ELEGANT AND  
HARDLY BIGGER  
THAN A TENNIS BALL.



© Hotel Das König Ludwig Wellness & SPA Resort Allgäu, Schwangau, Germany ▲  
© Brunssum Lindeplein, Netherlands; Photo: Dirk-Andre Betz ▼

## ≈ TYPICAL APPLICATIONS

Suitable for fountains up to a water height of 2 metres. Variable object lighting outside the water is also possible, for example in gardens. Flat water basins and trick fountains can be individually illuminated by the infinitely variable swivel spotlight.

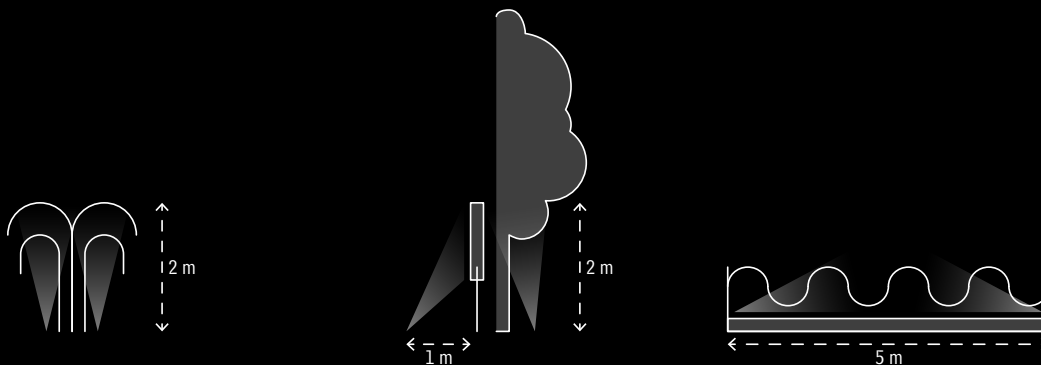

# # 4.0050 SURFACE-MOUNTED SPOTLIGHT

⚡ UP TO 675 LUMEN LIGHT INTENSITY  
PERFECT FOR FOUNTAINS AND WATER ATTRACTIONS

- ☰ · Protection class IP68 – up to 3m water depth
- Entirely made of stainless steel 316Ti 1.4571
- Mounting foot adjustable through 90°
- ...
- POW-LED cold white, warm white, neutral white
- Multichip POW-LED RGB-W
- Multichip POW-LED dynamic white
- operating mode: constant current
- Rotationally symmetric light distribution
- ...
- Cable pressure sleeve, stainless steel 316Ti
- Constant-current power source/RGB controller external
- Supplied with lamp and 3m of underwater cable

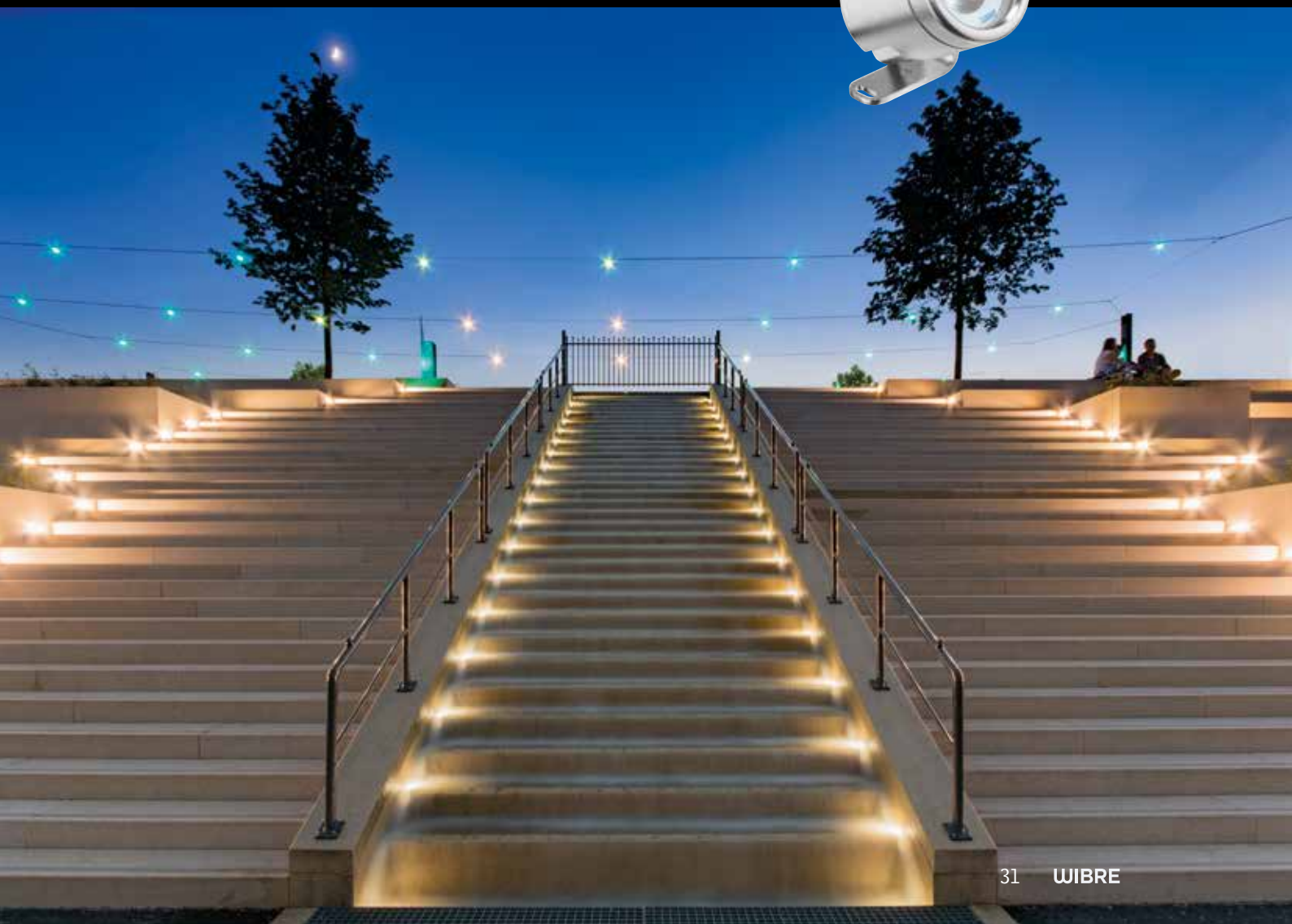

## [+] CONFIGURATION

### LIGHT COLORS



### BEAM ANGLES

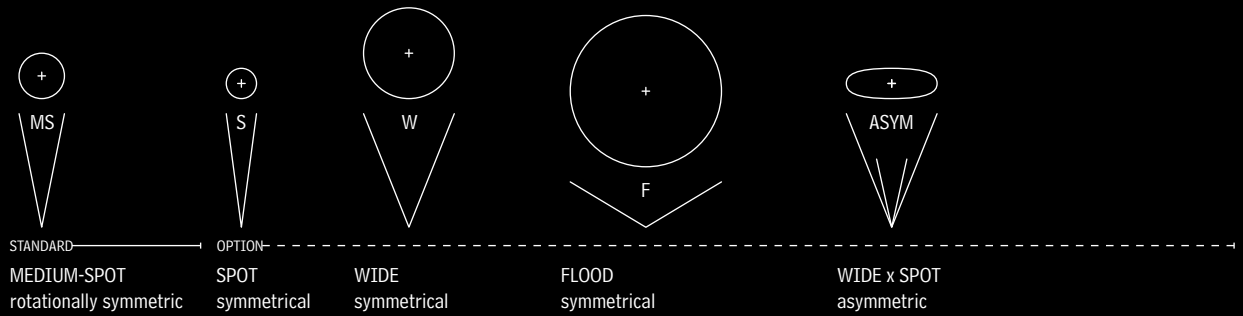

### ADDITIONAL PARTS

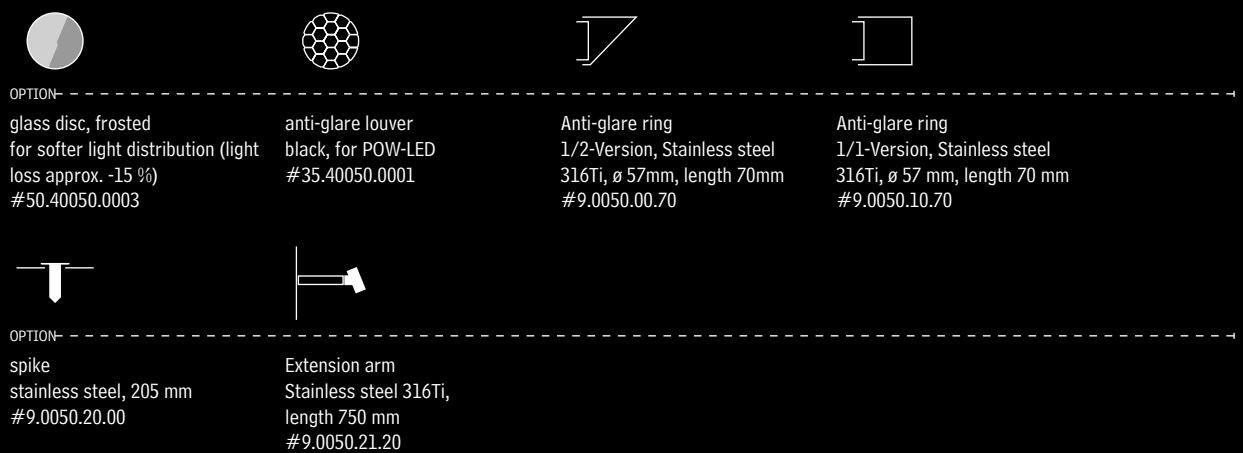

## DIMENSIONS

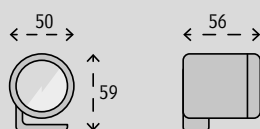



# 4.0050 SURFACE-MOUNTED SPOTLIGHT

IP68	STAINLESS STEEL V4A 1.4571 316Ti	ELECTRO POLISHED	POW-LED INCL.	3.000 K 4.500 K 6.000 K	RGB-W	DYNAMIC WHITE	CONSTANT CURRENT KONSTANT STROM	DALI 1-10V OPTIONAL DIMM	CABLE INCL.	max 3m	90°	CE	III
------	--	------------------	---------------	-------------------------------	-------	---------------	------------------------------------	-----------------------------	-------------	--------	-----	----	-----

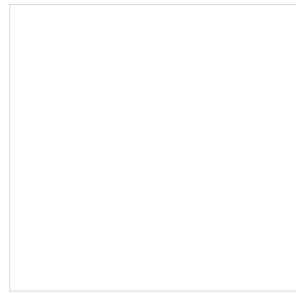
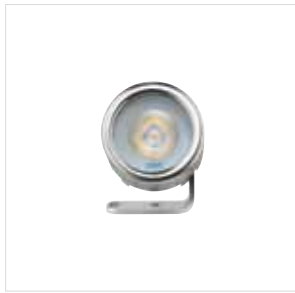

## MONOCHROME ILLUMINATION



#	4.0050.30.11	#	4.0050.30.12	#	4.0050.30.13
COLOR	6.000K cold white	COLOR	3.000K warm white	COLOR	4.500K neutral white
LED	1 POW-LED	LED	1 POW-LED	LED	1 POW-LED
LUMEN	675 lm	LUMEN	540 lm	LUMEN	575 lm
WATT	total 5 W	WATT	total 5 W	WATT	total 5 W
POWER	CC 350mA @12 V-DC	POWER	CC 350mA @12 V-DC	POWER	CC 350mA @12 V-DC
BEAM	25° medium-spot	BEAM	25° medium-spot	BEAM	25° medium-spot
CABLE	UW, 2x0,5 qmm	CABLE	UW, 2x0,5 qmm	CABLE	UW, 2x0,5 qmm
CONNECT	5.0635.65.10 max 1 5.0635.65.20 max 3	CONNECT	5.0635.65.10 max 1 5.0635.65.20 max 3	CONNECT	5.0635.65.10 max 1 5.0635.65.20 max 3

## DYNAMIC ILLUMINATION



#	4.0050.30.41	#	4.0050.30.42	#	4.0050.30.43	#	4.0050.30.80
COLOR	RGB-CW cold white 6000K	COLOR	RGB-WW warm white 3000K	COLOR	RGB-NW neutral white 4500K	COLOR	3000K-6000K dynamic white
LED	1 Multichip POW-LED	LED	1 Multichip POW-LED	LED	1 Multichip POW-LED	LED	1 Multichip POW-LED
LUMEN	cold white: 145 lm	LUMEN	warm white: 125 lm	LUMEN	neutral white: 135 lm	LUMEN	250-290 lm
WATT	all on 4 W	WATT	all on 4 W	WATT	all on 4 W	WATT	all on 4 W
POWER	CC 350mA @12 V-DC	POWER	CC 350mA @12 V-DC	POWER	CC 350mA @12 V-DC	POWER	CC 350mA @12 V-DC
BEAM	25° medium-spot	BEAM	25° medium-spot	BEAM	25° medium-spot	BEAM	25° medium-spot
CABLE	UW, 8x0,25 qmm	CABLE	UW, 8x0,25 qmm	CABLE	UW, 8x0,25 qmm	CABLE	UW, 8x0,25 qmm
CONNECT	5.0635.19.52 max 3 (12V-DC) or 12 (SELV)	CONNECT	5.0635.19.52 max 3 (12V-DC) or 12 (SELV)	CONNECT	5.0635.19.52 max 3 (12V-DC) or 12 (SELV)	CONNECT	5.0635.19.52 max 3 (12V-DC) or 12 (SELV)

” MADE TO STAND OUT.  
 IN DESIGN,  
 IN DYNAMISM,  
 IN PERFORMANCE.



© Herrenhäuser Gärten, Hannover, Germany; Planner: TGL Planungsgemeinschaft, Liegat PartG mbB ▲  
 © Place Jean Jaurès, Tours, France; Photo: Caroline Gasch; Partner: MW MarvalWay ▼

## ≈ TYPICAL APPLICATIONS

For fountains up to 5 metres high, the weak version of the spotlight is suitable. It can also be used for individual object lighting outside of the water. With the more powerful version you can illuminate fountains up to a height of 10 metres.

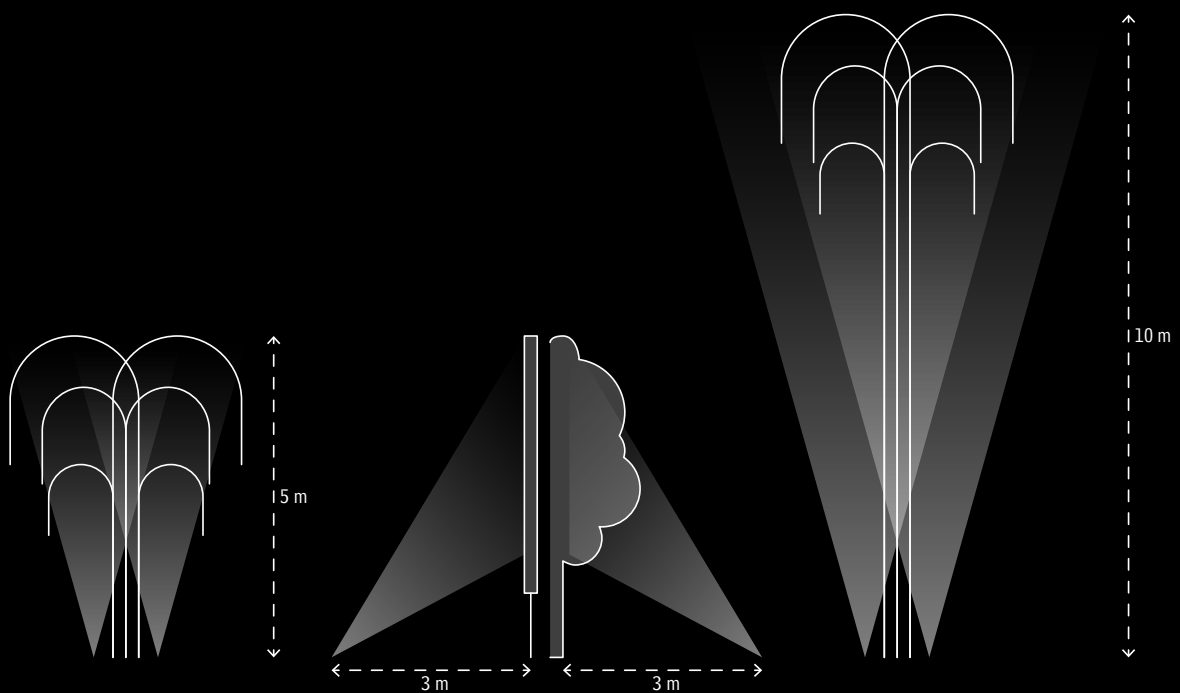

# # 4.0100 SURFACE-MOUNTED SPOTLIGHT

⚡ UP TO 2300 LUMEN LIGHT INTENSITY  
PERFECT FOR FOUNTAINS AND WATER ATTRACTIONS

- ☰ · Protection class IP68 – up to 3m water depth
- Entirely made of stainless steel 316Ti 1.4571
- Mounting foot adjustable through 90°
- ...
- POW-LED cold white, warm white, neutral white
- Multichip POW-LED RGB-W
- Multichip POW-LED dynamic white
- operating mode: constant current
- temperature controlled (onboard)
- surge protection
- Rotationally symmetric light distribution
- ...
- Cable pressure sleeve, stainless steel 316Ti
- Constant-current power source/RGB controller external
- Supplied with lamp and 3 m of underwater cable



## [+] CONFIGURATION

### LIGHT COLORS



### BEAM ANGLES

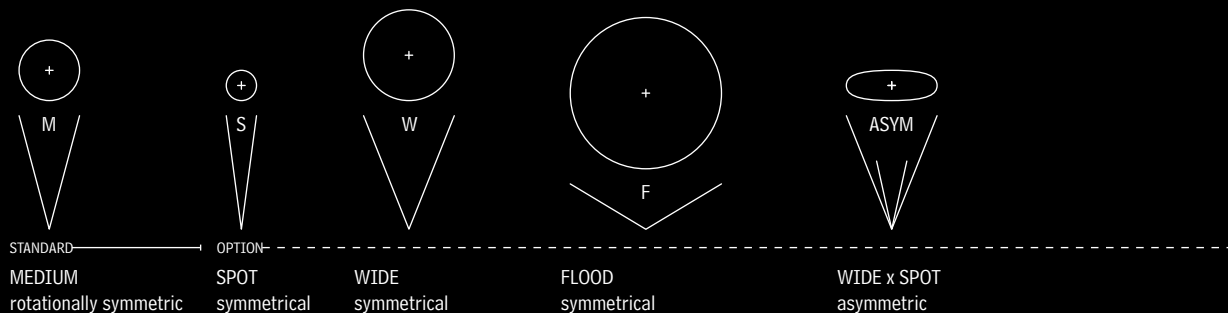

### ADDITIONAL PARTS



## [+] DIMENSIONS

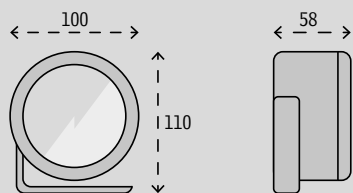

# 4.0100 SURFACE-MOUNTED SPOTLIGHT

IP68	STAINLESS STEEL V4A 1.4571 316Ti	ELECTRO POLISHED	POW-LED INCL.	3.000 K 4.500 K 6.000 K	RGB-W	DYNAMIC WHITE	DALI 1-10V OPTIONAL DIMM	CONSTANT CURRENT KONSTANT STROM	CABLE INCL.	max 3m	90°	CE	III
------	--	------------------	---------------	-------------------------------	-------	---------------	-----------------------------	------------------------------------	-------------	--------	-----	----	-----



## MONOCHROME ILLUMINATION

## DYNAMIC ILLUMINATION

#	<b>4.0100.00.11</b>
COLOR	6000K cold white
LED	4 POW-LED
LUMEN	750 lm
WATT	total 4,4 W
POWER	CC 350mA @12 V-DC
BEAM	30° medium
CABLE	UW, 2x1,5 qmm
CONNECT	5.0635.65.10 max 1 5.0635.65.20 max 3

#	<b>4.0100.30.11</b>
COLOR	6000K cold white
LED	4 POW-LED
LUMEN	2300 lm
WATT	total 18 W
POWER	CC 1200mA @12 V-DC
BEAM	30° medium
CABLE	UW, 2x1,5 qmm
CONNECT	5.0630.10.04 max 1 5.0630.00.04 max 1

#	<b>4.0100.00.41</b>
COLOR	RGB-CW cold white 6000K
LED	4 Multichip POW-LED
LUMEN	cold white: 350 lm
WATT	all on 10 W
POWER	CC 200mA @12 V-DC
BEAM	30° medium
CABLE	UW, 8x0,25 qmm
CONNECT	5.0620.19.52 max 1 (12V-DC) or 3 (SELV)

#	<b>4.0100.30.41</b>
COLOR	RGB-CW cold white 6000K
LED	4 Multichip POW-LED
LUMEN	cold white: 580 lm
WATT	all on 17 W
POWER	CC 350mA @12 V-DC
BEAM	30° medium
CABLE	UW, 8x0,25 qmm
CONNECT	5.0635.19.52 max 1 (12V-DC) or 3 (SELV)

#	<b>4.0100.00.12</b>
COLOR	3000K warm white
LED	4 POW-LED
LUMEN	650 lm
WATT	total 4,4 W
POWER	CC 350mA @12 V-DC
BEAM	30° medium
CABLE	UW, 2x1,5 qmm
CONNECT	5.0635.65.10 max 1 5.0635.65.20 max 3

#	<b>4.0100.30.12</b>
COLOR	3000K warm white
LED	4 POW-LED
LUMEN	1880 lm
WATT	total 18 W
POWER	CC 1200mA @12 V-DC
BEAM	30° medium
CABLE	UW, 2x1,5 qmm
CONNECT	5.0630.10.04 max 1 5.0630.00.04 max 1

#	<b>4.0100.00.42</b>
COLOR	RGB-WW warm white 3000K
LED	4 Multichip POW-LED
LUMEN	warm white: 300 lm
WATT	all on 10 W
POWER	CC 200mA @12 V-DC
BEAM	30° medium
CABLE	UW, 8x0,25 qmm
CONNECT	5.0620.19.52 max 1 (12V-DC) or 3 (SELV)

#	<b>4.0100.30.42</b>
COLOR	RGB-WW warm white 3000K
LED	4 Multichip POW-LED
LUMEN	warm white: 500 lm
WATT	all on 17 W
POWER	CC 350mA @12 V-DC
BEAM	30° medium
CABLE	UW, 8x0,25 qmm
CONNECT	5.0635.19.52 max 1 (12V-DC) or 3 (SELV)

#	<b>4.0100.00.13</b>
COLOR	4500K neutral white
LED	4 POW-LED
LUMEN	700 lm
WATT	total 4,4 W
POWER	CC 350mA @12 V-DC
BEAM	30° medium
CABLE	UW, 2x1,5 qmm
CONNECT	5.0635.65.10 max 1 5.0635.65.20 max 3

#	<b>4.0100.30.13</b>
COLOR	4500K neutral white
LED	4 POW-LED
LUMEN	2010 lm
WATT	total 18 W
POWER	CC 1200mA @12 V-DC
BEAM	30° medium
CABLE	UW, 2x1,5 qmm
CONNECT	5.0630.10.04 max 1 5.0630.00.04 max 1

#	<b>4.0100.00.43</b>
COLOR	RGB-NW neutral white 4500K
LED	4 Multichip POW-LED
LUMEN	neutral white: 330 lm
WATT	all on 10 W
POWER	CC 200mA @12 V-DC
BEAM	30° medium
CABLE	UW, 8x0,25 qmm
CONNECT	5.0620.19.52 max 1 (12V-DC) or 3 (SELV)

#	<b>4.0100.30.43</b>
COLOR	RGB-NW neutral white 4500K
LED	4 Multichip POW-LED
LUMEN	neutral white: 540 lm
WATT	all on 17 W
POWER	CC 350mA @12 V-DC
BEAM	30° medium
CABLE	UW, 8x0,25 qmm
CONNECT	5.0635.19.52 max 1 (12V-DC) or 3 (SELV)

#	<b>4.0100.30.80</b>
COLOR	3000K-6000K dynamic white
LED	4 Multichip POW-LED
LUMEN	1000-1160 lm
WATT	all on 17 W
POWER	CC 350mA @12 V-DC
BEAM	30° medium
CABLE	UW, 8x0,25 qmm
CONNECT	5.0635.19.52 max 1 (12V-DC) or 3 (SELV)



” UNIQUE AND  
VERSATILE  
IN FUNCTIONALITY  
AND APPLICATION.



© Plaza Bolívar, Maracay, Venezuela; Grupo MCI ▲  
© Le Pont Neuf, Toulouse, France; Photo: Patrice Nin ▼

## ≈ TYPICAL APPLICATIONS

For illuminating fountains up to a maximum height of 25 metres. The positioning and number of spotlights depends on the type of fountain - the closer the spotlight, the more intensive and accentuating the illumination. The spotlight is also ideally suited for powerful architectural lighting from the water.

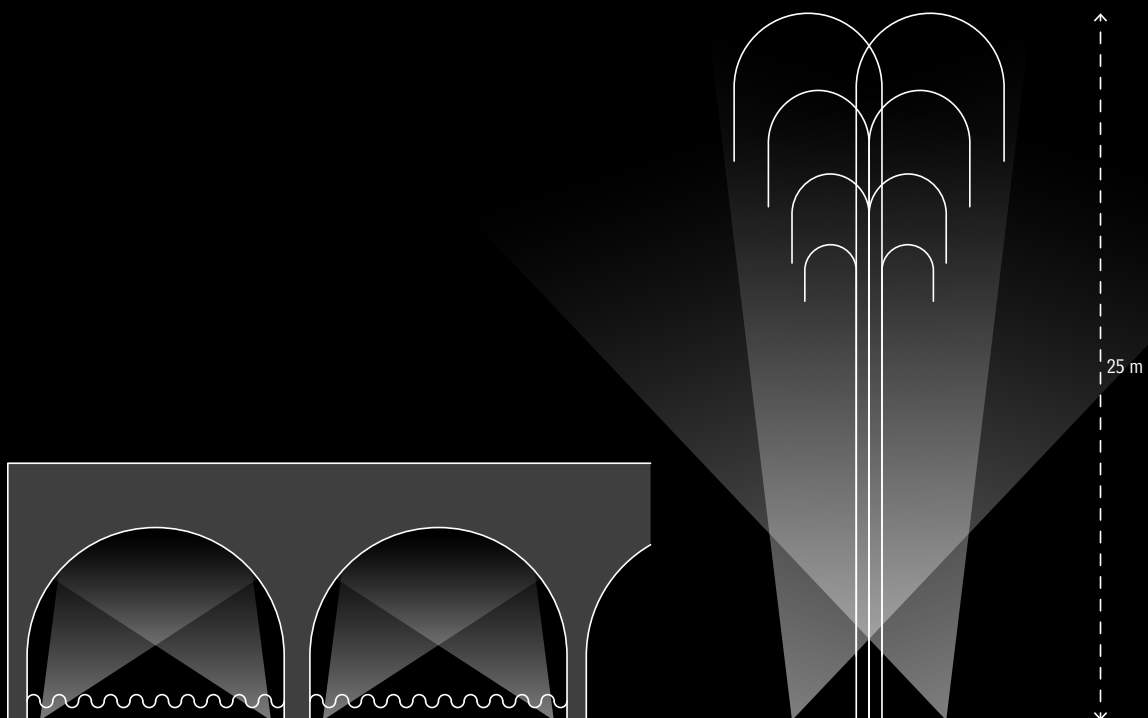

# # 4.0290 SURFACE-MOUNTED SPOTLIGHT

⚡ UP TO 4600 LUMEN LIGHT INTENSITY  
PERFECT FOR FOUNTAINS AND WATERSIDE ARCHITECTURE

- ☰ · Protection class IP68 – up to 3m water depth
- Entirely made of stainless steel 316Ti 1.4571
- Mounting foot adjustable through 90°
- ...
- POW-LED cold white, warm white, neutral white
- Multichip POW-LED RGB-W
- Multichip POW-LED dynamic white
- operating mode: constant current
- temperature controlled (onboard)
- surge protection
- Rotationally symmetric light distribution
- ...
- Cable sleeve, stainless steel 316Ti
- Constant-current power source/RGB controller external
- Supplied with lamp and 3 m of underwater cable

NEW  
↙







[+] CONFIGURATION

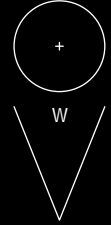

LIGHT COLORS

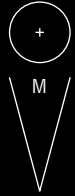
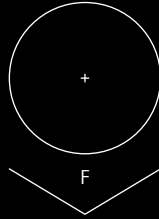
										
STANDARD							OPTION			
6000K cold white	4500K neutral white	3000K warm white	RGB-6000K + cold white	RGB-4500K + neutral white	RGB-3000K + warm white	Dynamic white 3000-6000K	red	green	blue	2700K

BEAM ANGLES

				
STANDARD	OPTION			
WIDE rotationally symmetrical	SPOT symmetrical	MEDIUM symmetrical	FLOOD symmetrical	WIDE x SPOT asymmetrical

ADDITIONAL PARTS

	
OPTION	OPTION
glass disc, frosted for softer light distribution (light loss approx. -15 %)	anti-glare louver black, for POW-LED
	
OPTION	
spike stainless steel, 305 mm	

📏 DIMENSIONS

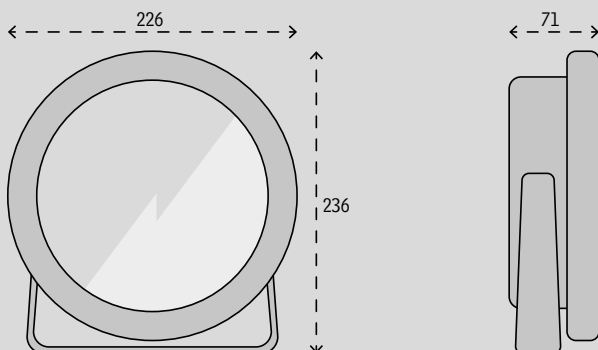

# 4.0290 SURFACE-MOUNTED SPOTLIGHT

IP68	STAINLESS STEEL V4A 1.4571 316Ti	ELECTRO POLISHED	POW-LED INCL.	3.000 K 4.500 K 6.000 K	RGB-W	DYNAMIC WHITE	DALI 1-10V OPTIONAL DIMM	CONSTANT CURRENT KONSTANT STROM	CABLE INCL.	max 3m	90°	CE	III
------	--	------------------	---------------	-------------------------------	-------	---------------	-----------------------------	------------------------------------	-------------	--------	-----	----	-----

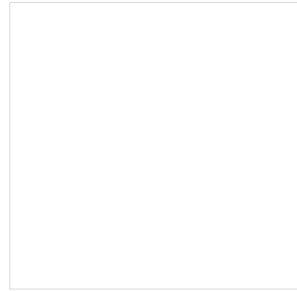

## MONOCHROME ILLUMINATION

#	4.0290.00.11	#	4.0290.00.12	#	4.0290.00.13
COLOR	6.000K cold white	COLOR	3.000K warm white	COLOR	4.500K neutral white
LED	8 POW-LED	LED	8 POW-LED	LED	8 POW-LED
LUMEN	4600 lm	LUMEN	3760 lm	LUMEN	4024 lm
WATT	total 31 W	WATT	total 31 W	WATT	total 31 W
POWER	CC 2400mA @12 V-DC	POWER	CC 2400mA @12 V-DC	POWER	CC 2400mA @12 V-DC
BEAM	50° symmetrisch	BEAM	50° symmetrisch	BEAM	50° symmetrisch
CABLE	UW, 2x2,5 qmm	CABLE	UW, 2x2,5 qmm	CABLE	UW, 2x2,5 qmm
CONNECT	5.0630.10.08 max 1	CONNECT	5.0630.10.08 max 1	CONNECT	5.0630.10.08 max 1

## DYNAMIC ILLUMINATION

#	4.0290.00.41	#	4.0290.00.42	#	4.0290.00.43	#	4.0290.00.80
COLOR	RGB-CW cold white 6000K	COLOR	RGB-VW warm white 3000K	COLOR	RGB-NW neutral white 4500K	COLOR	3000K-6000K dynamic white
LED	8 Multichip POW-LED	LED	8 Multichip POW-LED	LED	8 Multichip POW-LED	LED	8 Multichip POW-LED
LUMEN	cold white: 1160 lm	LUMEN	warm white: 1000 lm	LUMEN	neutral white: 1080 lm	LUMEN	2000-2320 lm
WATT	all on 50 W	WATT	all on 50 W	WATT	all on 50 W	WATT	all on 50 W
POWER	CC 700mA @12 V-DC	POWER	CC 700mA @12 V-DC	POWER	CC 700mA @12 V-DC	POWER	CC 700mA @12 V-DC
BEAM	50° symmetrisch	BEAM	50° symmetrisch	BEAM	50° symmetrisch	BEAM	50° symmetrisch
CABLE	UW, 10x0,5 qmm	CABLE	UW, 10x0,5 qmm	CABLE	UW, 10x0,5 qmm	CABLE	UW, 10x0,5 qmm
CONNECT	5.0670.19.52 max 1	CONNECT	5.0670.19.52 max 1	CONNECT	5.0670.19.52 max 1	CONNECT	5.0670.19.52 max 1

” THIS IS BIG.  
LIGHT IN  
A POWER  
NEVER SEEN  
BEFORE.



© Jet d'eau, Geneva, Switzerland, Photo: Yvon Labarthe ▲  
© UNDER Restaurant, Norway; Photo: Tomas Majewski; Partner: Luminator AS ▼

## ≈ TYPICAL APPLICATIONS

For illuminating fountains up to a maximum height of 50 metres. The positioning and number of spotlights depends on the type of fountain - the closer the spotlight, the more intensive and accentuating the illumination. The spotlight is also ideally suited for powerful architectural lighting from the water.

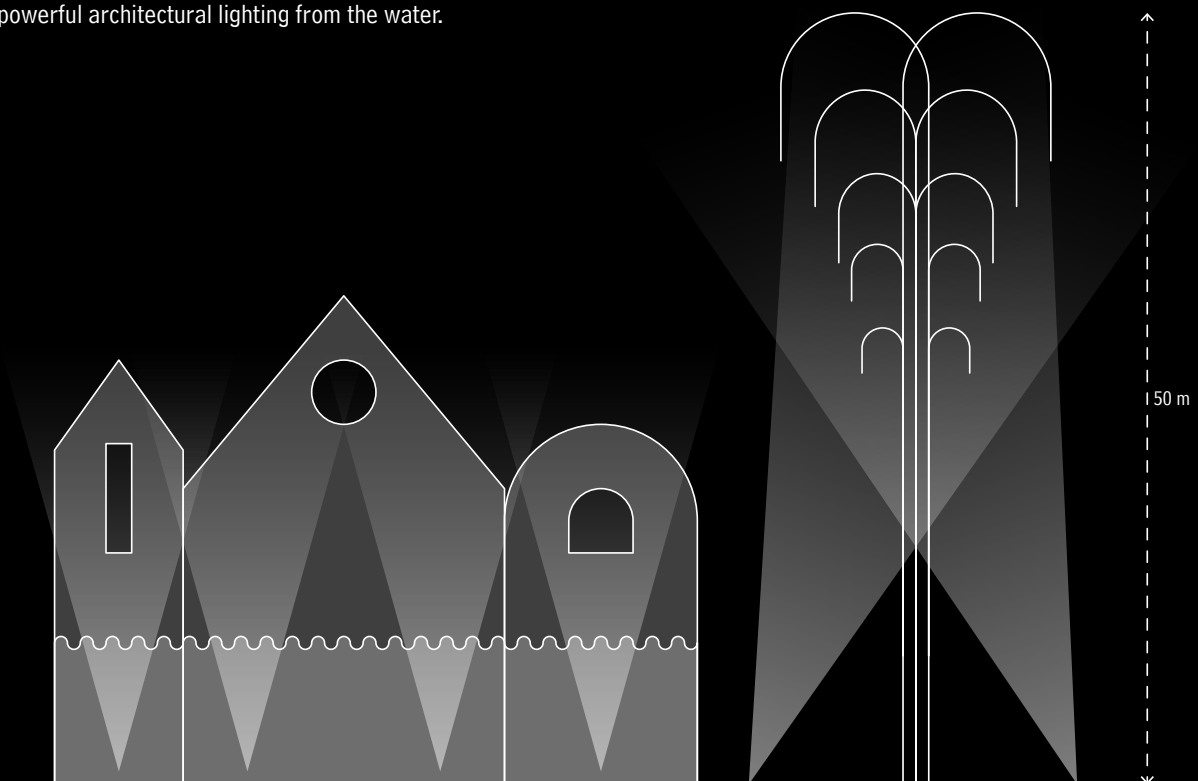



# # 4.0490 SURFACE-MOUNTED SPOTLIGHT

⚡ UP TO 18600 LUMEN LIGHT INTENSITY  
PERFECT FOR FOUNTAINS AND WATERSIDE ARCHITECTURE

- ☰ · Protection class IP68 – up to 3m water depth
- Entirely made of stainless steel 316Ti 1.4571
- Mounting foot adjustable through 90°
- ...
- POW-LED cold white, warm white, neutral white
- Multichip POW-LED RGB-W
- Multichip POW-LED dynamic white
- operating mode: constant current
- temperature controlled (onboard)
- surge protection
- Rotationally symmetric light distribution
- ...
- Cable sleeve, stainless steel 316Ti
- Constant-current power source/RGB controller external
- Supplied with lamp and 3 m of underwater cable

NEW  
↙

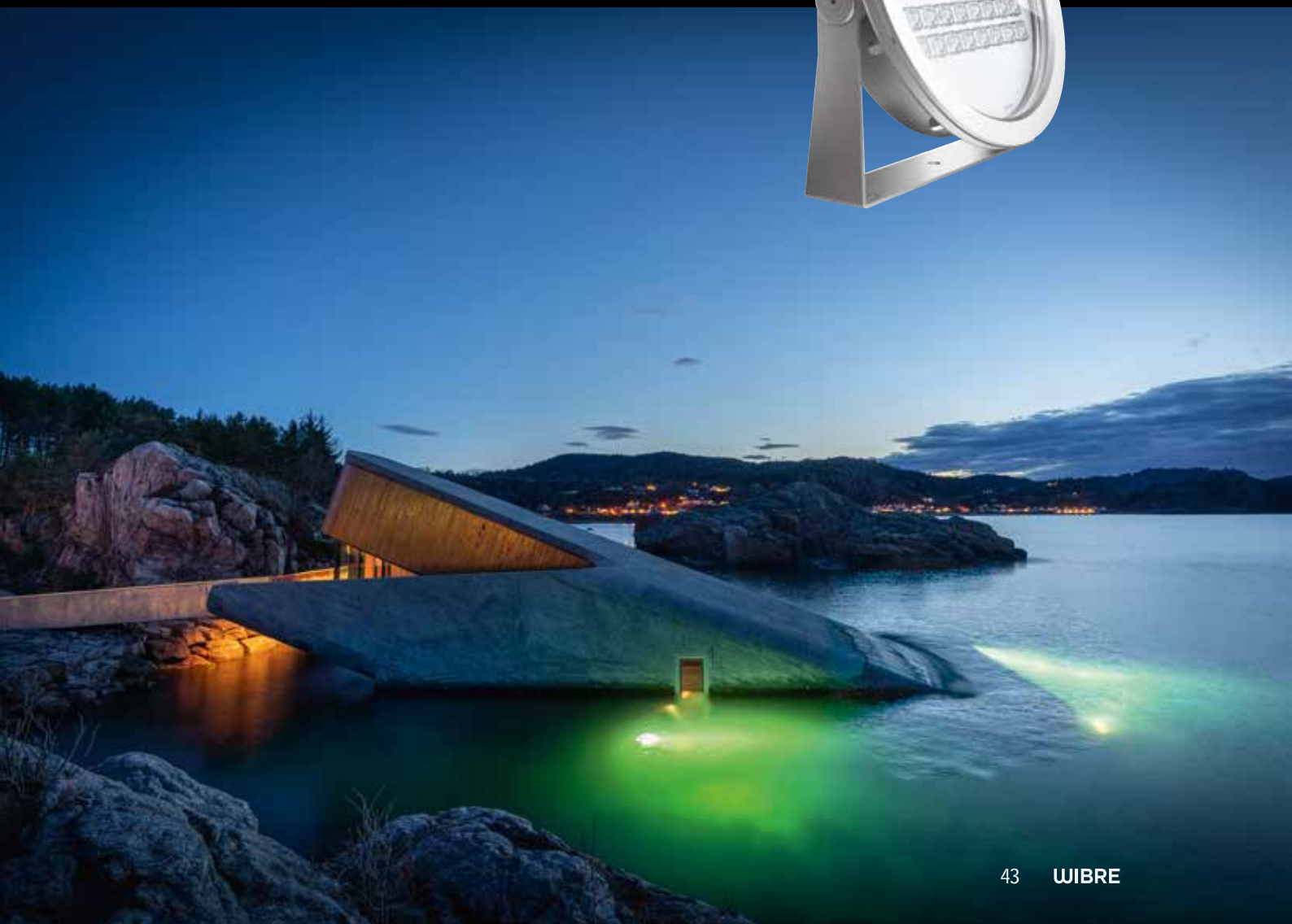

## [+] CONFIGURATION

### LIGHT COLORS



STANDARD

6000K  
cold white

4500K  
neutral white

3000K  
warm white

RGB-6000K  
+ cold white

RGB-4500K  
+ neutral white

RGB-3000K  
+ warm white

### BEAM ANGLES

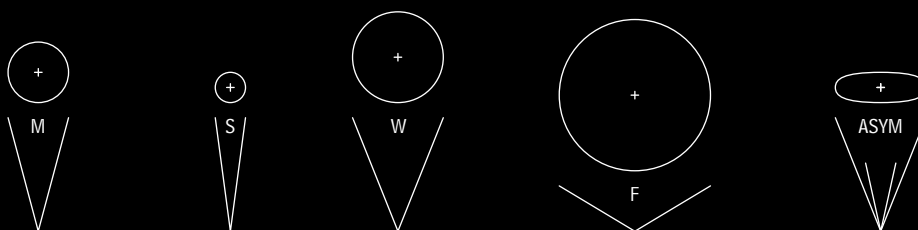

STANDARD

MEDIUM  
rotationally symmetric

OPTION

SPOT  
symmetrical

WIDE  
symmetrical

FLOOD  
symmetrical

WIDE x SPOT  
asymmetric

### ADDITIONAL PARTS



OPTION

glass disc, frosted  
for softer light distribution  
(light loss approx. -15 %)



anti-glare louver  
black, for POW-LED



OPTION

spike  
stainless steel, 305 mm

## [+] DIMENSIONS

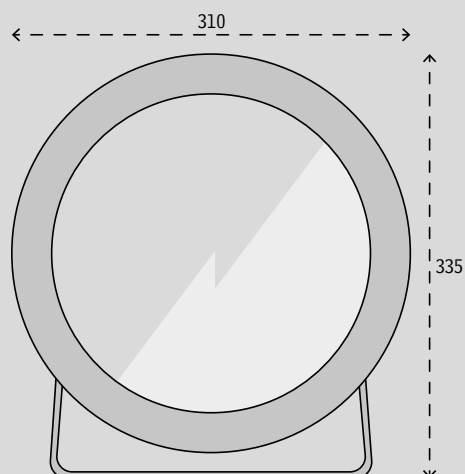

WIBRE 44

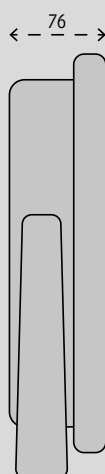

# 4.0490 SURFACE-MOUNTED SPOTLIGHT

IP68	STAINLESS STEEL V4A 1.4571 316Ti	ELECTRO POLISHED	POW-LED INCL.	3.000 K 4.500 K 6.000 K	RGB-W	DYNAMIC WHITE	DALI 1-10V OPTIONAL DIMM	CONSTANT CURRENT KONSTANT STROM	CABLE INCL.	max 3m	90°	CE	III
------	--	------------------	---------------	-------------------------------	-------	---------------	-----------------------------	------------------------------------	-------------	--------	-----	----	-----

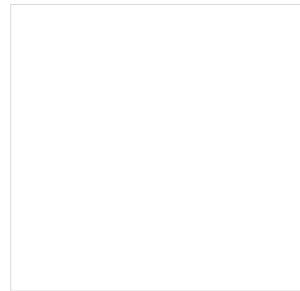

## MONOCHROME ILLUMINATION

#	4.0490.00.11	#	4.0490.00.12	#	4.0490.00.13
COLOR	6000K cold white	COLOR	3000K warm white	COLOR	4500K neutral white
LED	32 POW-LED	LED	32 POW-LED	LED	32 POW-LED
LUMEN	18600 lm	LUMEN	15040 lm	LUMEN	16080 lm
WATT	total 120 W	WATT	total 120 W	WATT	total 120 W
POWER	CV 12 V-DC	POWER	CV 12 V-DC	POWER	CV 12 V-DC
BEAM	30° symmetrisch	BEAM	30° symmetrisch	BEAM	30° symmetrisch
CABLE	UW, 5x1,5 qmm	CABLE	UW, 5x1,5 qmm	CABLE	UW, 5x1,5 qmm
CONNECT	5.0630.10.32 max 1	CONNECT	5.0630.10.32 max 1	CONNECT	5.0630.10.32 max 1

## DYNAMIC ILLUMINATION

#	4.0490.00.41	#	4.0490.00.42	#	4.0490.00.43
COLOR	RGB-CW cold white 6000K	COLOR	RGB-WW warm white 3000K	COLOR	RGB-NW neutral white 4500K
LED	32 Multichip POW-LED	LED	32 Multichip POW-LED	LED	32 Multichip POW-LED
LUMEN	cold white: 4640 lm	LUMEN	warm white: 3760 lm	LUMEN	neutral white: 4020 lm
WATT	all on 140 W	WATT	all on 140 W	WATT	all on 140 W
POWER	CC 12 V-DC	POWER	CC 12 V-DC	POWER	CC 12 V-DC
BEAM	30° symmetrisch	BEAM	30° symmetrisch	BEAM	30° symmetrisch
CABLE	UW, 41x0,5 qmm	CABLE	UW, 41x0,5 qmm	CABLE	UW, 41x0,5 qmm
CONNECT	5.0670.49.52 max 1	CONNECT	5.0670.49.52 max 1	CONNECT	5.0670.49.52 max 1

← LIGHT UP YOUR FOUNTAINS  
AND WATERSIDE ARCHITECTURE

RETROFIT YOUR  
OLD SPOTLIGHTS





” BESTSELLER REMAINS  
BESTSELLER.  
WITH QUALITY.  
WITH PERFORMANCE.  
WITH POW-LED.



© Actionbad Kokpunkten, Västerås, Sweden; Partner: Malux Sweden ▲  
© Hotel Traube Tonbath, Germany; Photo: Henrik Morlock ▼

## ≈ TYPICAL APPLICATIONS

This retrofit spotlight is intended as a replacement for existing spotlights with halogen technology, primarily types 4.0267 and 4.0271 and various other makes. This spotlight has everything for a hassle-free change. Better lighting power, considerably less consumption, long service life and safety - standard-conforming operation in water accessible to people is permitted, thanks to the 12 V-DC technology.

### IT HAS NEVER BEEN EASIER. A CHANGE IN 5 STEPS

1. REMOVE OLD SPOTLIGHT
  2. CONNECT EXISTING CABLE
  3. INSERT THE NEW SPOTLIGHT
  4. SCREW THE SPOTLIGHT TIGHT
  5. CHANGE THE CONTROL DEVICE
- LIGHT ON

## # 4.0291 RETROFIT-SPOTLIGHT

⚡ UP TO 6900 LUMEN LIGHT INTENSITY  
SUSTAINABLE REPLACEMENT FOR HALOGEN SPOTLIGHTS

- ☰ · Protection class IP68 – up to 5m water depth
- Entirely made of stainless steel 316Ti 1.4571, epolished
- Round attachment cover, made of stainless steel 316Ti, height 13 mm
- ...
- POW-LED cold white, warm white, neutral white
- POW-LED royal blue
- Multichip POW-LED RGB-W
- operating mode: constant current
- temperature controlled (onboard)
- surge protection
- light distribution especially for swimming pool lighting "asymmetric Mixflux"
- ...
- Constant-current power source/RGB-W-controller ordered separately
- Supplied without cable



[+] CONFIGURATION

LIGHT COLORS



BEAM ANGLES

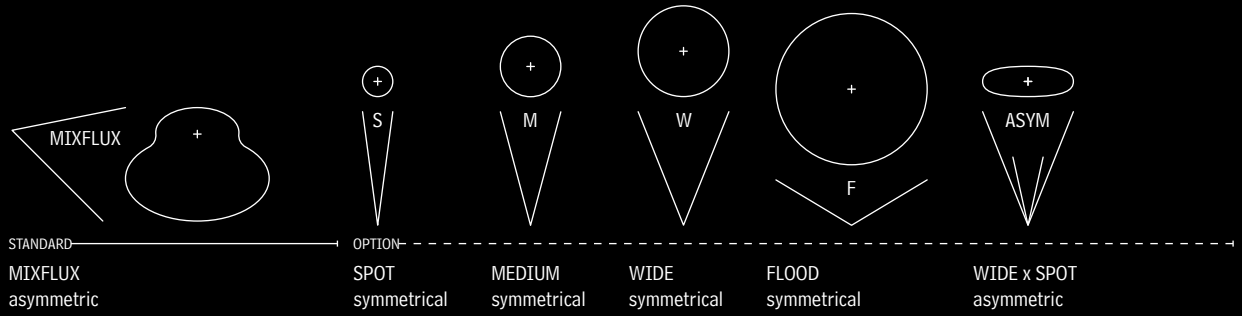

ADDITIONAL PARTS



OPTION  
glass disc, frosted  
for softer light distribution  
(light loss approx. -15 %)  
#50.40292.0004

[+] DIMENSIONS

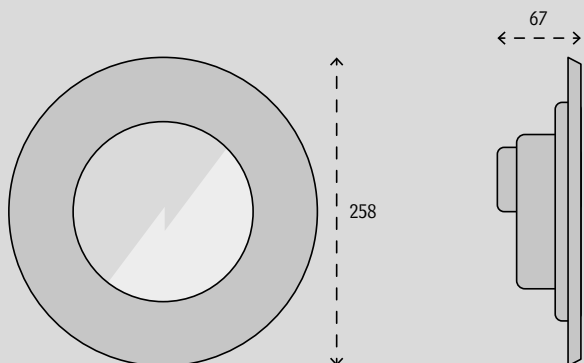

# 4.0291 RETROFIT-SPOTLIGHT

IP68	STAINLESS STEEL V4A 1.4571 316Ti	POW-LED INCL.	3.000 K 4.500 K 6.000 K BLUE	RGB-W	CONSTANT CURRENT KONSTANT STROM	DALI 1-10 V OPTIONAL DIMM	CABLE EXCL.	max 5m			CE	III
------	---	------------------	---------------------------------------	-------	--	------------------------------------	----------------	--------	--	--	----	-----



## MONOCHROME ILLUMINATION

#	4.0291.00.11	#	4.0291.00.12	#	4.0291.00.13	#	4.0291.00.16
COLOR	6000K cold white	COLOR	3000K warm white	COLOR	4500K neutral white	COLOR	royal blue (450 nm)
LED	12 POW-LED	LED	12 POW-LED	LED	12 POW-LED	LED	48 POW-LED
LUMEN	6900 lm	LUMEN	5640 lm	LUMEN	6036 lm	LUMEN	500mW/LED
WATT	total 47 W	WATT	total 47 W	WATT	total 47 W	WATT	total 49,5 W
POWER	CC 3600mA @12 V-DC	POWER	CC 3600mA @12 V-DC	POWER	CC 3600mA @12 V-DC	POWER	CC 3600mA @12 V-DC
BEAM	asymmetrisch Mixflux	BEAM	asymmetrisch Mixflux	BEAM	asymmetrisch Mixflux	BEAM	asymmetrisch Mixflux
CABLE	UW, 2x2,5 qmm	CABLE	UW, 2x2,5 qmm	CABLE	UW, 2x2,5 qmm	CABLE	UW, 2x2,5 qmm
CONNECT	5.0630.01.12 max 1 5.0630.03.12 max 3	CONNECT	5.0630.01.12 max 1 5.0630.03.12 max 3	CONNECT	5.0630.01.12 max 1 5.0630.03.12 max 3	CONNECT	5.0630.01.12 max 1 5.0630.03.12 max 3

## DYNAMIC ILLUMINATION

#	4.0291.00.41	#	4.0291.00.42	#	4.0291.00.43
COLOR	RGB-CW cold white 6000K	COLOR	RGB-WW warm white 3000K	COLOR	RGB-NW neutral white 4500K
LED	12 Multichip POW-LED	LED	12 Multichip POW-LED	LED	12 Multichip POW-LED
LUMEN	cold white: 2100 lm	LUMEN	warm white: 1800 lm	LUMEN	neutral white: 1920 lm
WATT	all on 75 W	WATT	all on 75 W	WATT	all on 75 W
POWER	CC 1400mA @12 V-DC	POWER	CC 1400mA @12 V-DC	POWER	CC 1400mA @12 V-DC
BEAM	asymmetrisch Mixflux	BEAM	asymmetrisch Mixflux	BEAM	asymmetrisch Mixflux
CABLE	UW, 1x4,0 + 4x1,0 + 2x0,25 qmm	CABLE	UW, 1x4,0 + 4x1,0 + 2x0,25 qmm	CABLE	UW, 1x4,0 + 4x1,0 + 2x0,25 qmm
CONNECT	5.0630.09.52 max 1	CONNECT	5.0630.09.52 max 1	CONNECT	5.0630.09.52 max 1

### USE IN SALT WATER

This spotlight is also available as a salt-water version. Spotlights for salty water (with a saltwater concentration of up to 3.5 %) are made of special V4A stainless steel 904L (1.4539).



” SAVE 6500 WATTS  
PER HOUR.\*  
IT'S NEVER  
BEEN EASIER.



© Campus Sursee, Switzerland; Photo: Samuel Trümpy ▲  
© AQUAtoll Neckarsulm, Germany; Photo: Benjamin Pfendt ▼

## ≈ TYPICAL APPLICATIONS

This retrofit insert is intended for existing 4.2000 type spotlights, which are primarily installed in sports pools. The insert has everything for a hassle-free change to LED. Better lighting power, considerably less consumption, long service life, safety and sophisticated temperature management. The latter is important in order to put the spotlight back into operation in accordance with regulations, namely as a closed unit with a cover plate.

### IT HAS NEVER BEEN EASIER. A CHANGE IN 5 STEPS

1. REMOVE OLD SPOTLIGHT UNIT
  2. PUSH-IN AND ALIGN THE NEW INSERT
  3. MOUNT THE COVER PLATE
  4. CLOSE THE INSPECTION FLAP
  5. CONNECT TO THE CONTROL DEVICE
- LIGHT ON

\*Compared to 24 floodlights in a competition pool with 400 Watt each.



## # 4.2013 RETROFIT-INSERTION FOR 4.2000

⚡ UP TO 18600 LUMEN LIGHT INTENSITY  
SUSTAINABLE REPLACEMENT FOR 250/400 W HIT

- ☰ · Retrofit insertion for installation in existing spotlights 4.2000
- for retrofitting halogen to LED
- Entirely made of high-quality anodized aluminum
- ...
- POW-LED cold white, warm white, neutral white
- Multichip POW-LED RGB-W
- operating mode mono: constant voltage
- operating mode RGB-W: constant current
- temperature controlled (onboard)
- surge protection
- light distribution especially for swimming pool lighting "asymmetric Mixflux"
- ...
- Delivered ready for connection
- incl. end cover with integrated access port for easy installation
- Constant-voltage power source/RGB-W controller ordered separately
- Supplied with 2 m of special underwater cable



[+] CONFIGURATION

LIGHT COLORS



STANDARD

6000K cold white    4500K neutral white    3000K warm white    RGB-6000K + cold white    RGB-4500K + neutral white    RGB-3000K + warm white

BEAM ANGLES

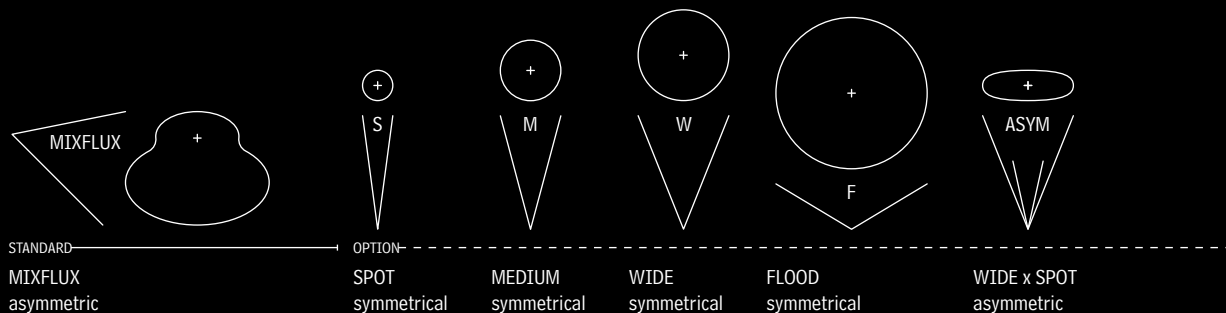

📏 DIMENSIONS

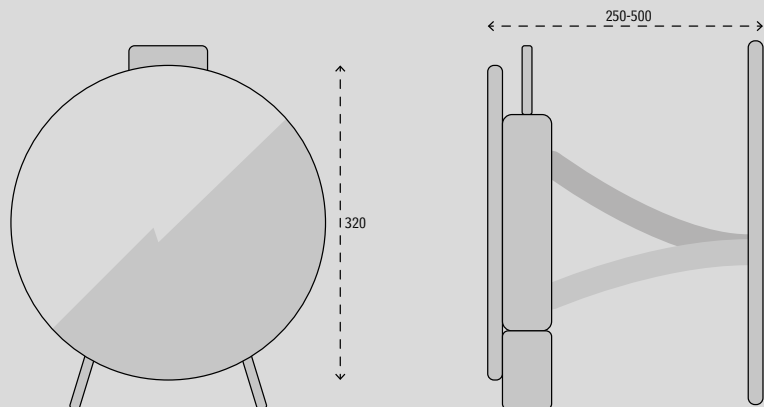

# 4.2013 RETROFIT-INSERTION FOR 4.2000

ALU	POW-LED INCL.	3.000 K 4.500 K 6.000 K	CONSTANT VOLTAGE KONSTANT SPANNUNG	CABLE INCL.	max 3m	←	CE	III
-----	---------------	-------------------------------	---------------------------------------	-------------	--------	---	----	-----

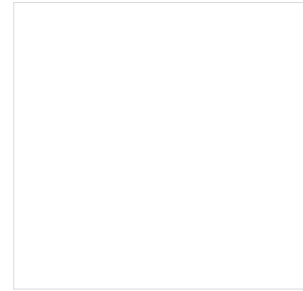

## MONOCHROME ILLUMINATION

#	4.2013.00.11	#	4.2013.00.12	#	4.2013.00.13
COLOR	6000K cold white	COLOR	3000K warm white	COLOR	4500K neutral white
LED	32 POW-LED	LED	32 POW-LED	LED	32 POW-LED
LUMEN	18600 lm	LUMEN	15040 lm	LUMEN	16080 lm
WATT	total 124 W	WATT	total 124 W	WATT	total 124 W
POWER	CV 12 V-DC	POWER	CV 12 V-DC	POWER	CV 12 V-DC
BEAM	asymmetrisch Mixflux	BEAM	asymmetrisch Mixflux	BEAM	asymmetrisch Mixflux
CABLE	UW, 5x1,5 qmm	CABLE	UW, 5x1,5 qmm	CABLE	UW, 5x1,5 qmm
CONNECT	5.0630.20.32 max 1	CONNECT	5.0630.20.32 max 1	CONNECT	5.0630.20.32 max 1

## DYNAMIC ILLUMINATION

#	4.2013.00.41	#	4.2013.00.42	#	4.2013.00.43
COLOR	RGB-CW cold white 6000K	COLOR	RGB-CW warm white 3000K	COLOR	RGB-CW neutral white 4500K
LED	32 Multichip POW-LED	LED	32 Multichip POW-LED	LED	32 Multichip POW-LED
LUMEN	cold white: 4640 lm	LUMEN	warm white: 3760 lm	LUMEN	neutral white: 4020 lm
WATT	all on 152 W	WATT	all on 152 W	WATT	all on 152 W
POWER	CC 12 V-DC	POWER	CC 12 V-DC	POWER	CC 12 V-DC
BEAM	asymmetrisch Mixflux	BEAM	asymmetrisch Mixflux	BEAM	asymmetrisch Mixflux
CABLE	UW, 41x0,5 qmm	CABLE	UW, 41x0,5 qmm	CABLE	UW, 41x0,5 qmm
CONNECT	5.0670.59.52 max 1	CONNECT	5.0670.59.52 max 1	CONNECT	5.0670.59.52 max 1

” NEW SHINE  
FOR OLDER  
SPORTS POOLS.  
ENDLESS  
ADDED VALUE.



© Hallenbad Biel-Bienne, Switzerland; Photo: Tridea Grafik Fotografie Webdesign ▲  
© THERMEN & BADEWELT SINSHEIM ▼

## ≈ TYPICAL APPLICATIONS

This retrofit insert is intended for existing 4.1900 type spotlights, which are primarily installed in sports pools. The insert has everything for a hassle-free change to LED. Better lighting power, considerably less consumption, long service life, safety and sophisticated temperature management. The latter is important in order to put the spotlight back into operation in accordance with regulations, namely as a closed unit with a cover plate.

### IT HAS NEVER BEEN EASIER. A CHANGE IN 5 STEPS

1. REMOVE OLD SPOTLIGHT UNIT
  2. PUSH-IN AND ALIGN THE NEW INSERT
  3. MOUNT THE COVER PLATE
  4. CLOSE THE INSPECTION FLAP
  5. CONNECT TO THE CONTROL DEVICE
- LIGHT ON



## # 4.1913 RETROFIT-INSERTION FOR 4.1900

⚡ UP TO 9300 LUMEN LIGHT INTENSITY  
SUSTAINABLE REPLACEMENT FOR 250 W HIT

- ☰ · Retrofit insertion for installation in existing spotlights 4.1900
- for retrofitting halogen to LED
- Entirely made of high-quality anodized aluminum
- ...
- POW-LED cold white, warm white, neutral white
- Multichip POW-LED RGB-W
- operating mode mono: constant voltage
- operating mode RGB-W: constant current
- temperature controlled (onboard)
- surge protection
- light distribution especially for swimming pool lighting "asymmetric Mixflux"
- ...
- Delivered ready for connection
- incl. end cover with integrated access port for easy installation
- Constant-voltage power source/RGB-W controller ordered separately
- Supplied with 2 m of special underwater cable

NEW  
↙





[+] CONFIGURATION

LIGHT COLORS



STANDARD

6000K cold white    4500K neutral white    3000K warm white    RGB-6000K + cold white    RGB-4500K + neutral white    RGB-3000K + warm white

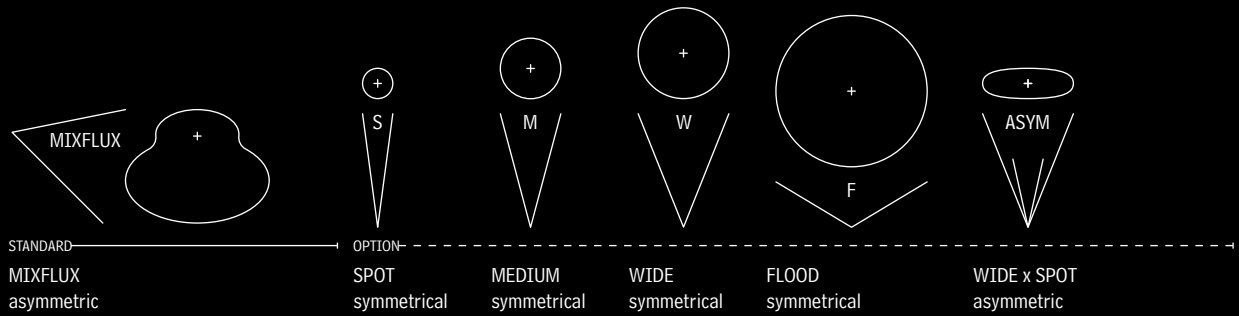

BEAM ANGLES

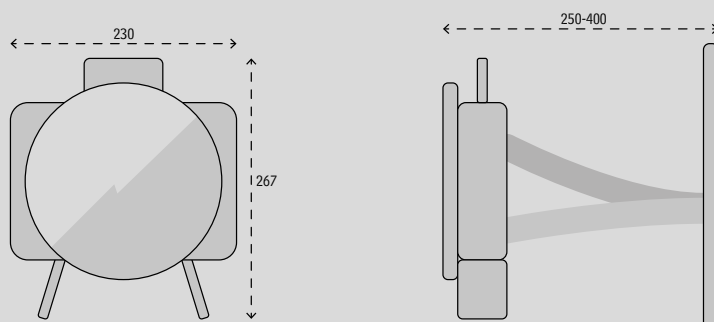

📏 DIMENSIONS



## 4.1913 RETROFIT-INSERTION FOR 4.1900

ALU	POW-LED INCL.	3.000 K 4.500 K 6.000 K	CONSTANT VOLTAGE — KONSTANT SPANNUNG	CABLE INCL.	 max 3m		CE	
-----	------------------	-------------------------------	--	----------------	---	---	----	---

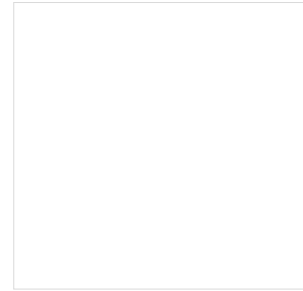
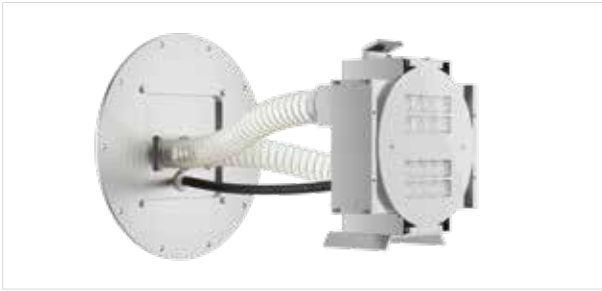

### MONOCHROME ILLUMINATION

#	4.1913.00.11	#	4.1913.00.12	#	4.1913.00.13
COLOR	6000K cold white	COLOR	3000K warm white	COLOR	4500K neutral white
LED	16 POW-LED	LED	16 POW-LED	LED	16 POW-LED
LUMEN	9300 lm	LUMEN	7520 lm	LUMEN	8040 lm
WATT	total 62 W	WATT	total 62 W	WATT	total 62 W
POWER	CV 12 V-DC	POWER	CV 12 V-DC	POWER	CV 12 V-DC
BEAM	asymmetrisch Mixflux	BEAM	asymmetrisch Mixflux	BEAM	asymmetrisch Mixflux
CABLE	UW, 5x1,5 qmm	CABLE	UW, 5x1,5 qmm	CABLE	UW, 5x1,5 qmm
CONNECT	5.0630.20.16 max 1	CONNECT	5.0630.20.16 max 1	CONNECT	5.0630.20.16 max 1

### DYNAMIC ILLUMINATION

#	4.1913.00.41	#	4.1913.00.42	#	4.1913.00.43
COLOR	RGB-CW cold white 6000K	COLOR	RGB-CW warm white 3000K	COLOR	RGB-CW neutral white 4500K
LED	16 Multichip POW-LED	LED	16 Multichip POW-LED	LED	16 Multichip POW-LED
LUMEN	cold white: 2320 lm	LUMEN	warm white: 1880 lm	LUMEN	neutral white: 2010 lm
WATT	all on 76 W	WATT	all on 76 W	WATT	all on 76 W
POWER	CC 12 V-DC	POWER	CC 12 V-DC	POWER	CC 12 V-DC
BEAM	asymmetrisch Mixflux	BEAM	asymmetrisch Mixflux	BEAM	asymmetrisch Mixflux
CABLE	UW, 25x0,5 qmm	CABLE	UW, 25x0,5 qmm	CABLE	UW, 25x0,5 qmm
CONNECT	5.0670.39.52 max 1	CONNECT	5.0670.39.52 max 1	CONNECT	5.0670.39.52 max 1

← RETROFIT YOUR  
OLD SPOTLIGHTS

LARC68: HIGHLY RESISTANT  
ARCHITECTURAL LIGHTING



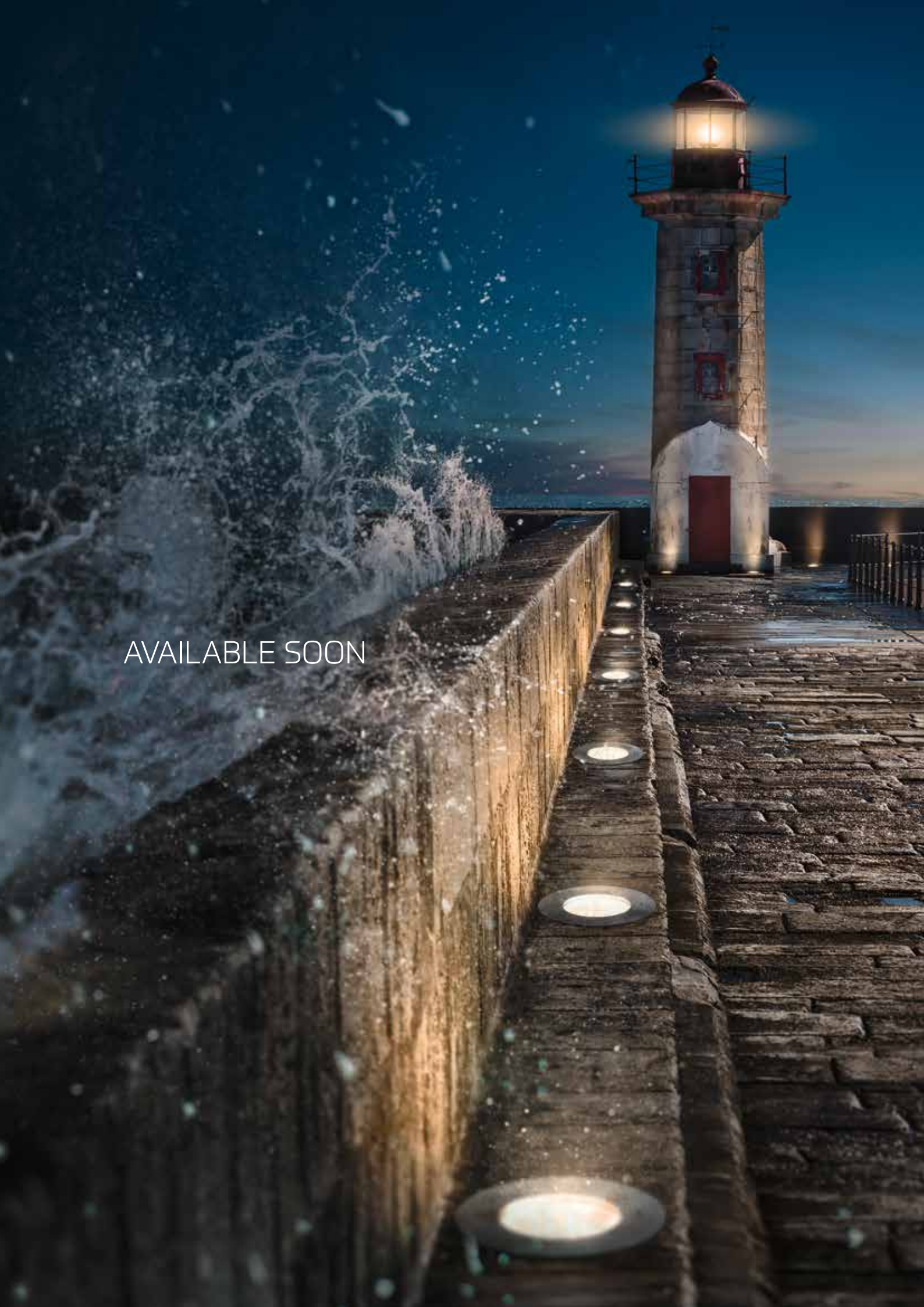

AVAILABLE SOON





# LARC68

highly resistant architectural lighting **by** WIBRE



SIZE	POWER	ENERGY	PROTECT	STAINLESS STEEL
194 MM	1800 LM	12 W	IP68 SYSTEM	V4A 316TI
SMART	COLOR		SAFETY	PROTECT
RGB-W DYN-W	2700K 3000K 4500K 6000K		12 V-DC	TEMP CONTROL
DIMM	BEAM		MULTIPLE	ASSISTANCE
DALI DMX	SPOT MEDIUM FLOOD ASYMMETRIC		FEA- TURES	LONG-TERM SUPPORT



SIZE	POWER	ENERGY	PROTECT	STAINLESS STEEL
244 MM	3600 LM	25 W	IP68 SYSTEM	V4A 316TI
SMART	COLOR		SAFETY	PROTECT
RGB-W DYN-W	2700K 3000K 4500K 6000K		12 V-DC	TEMP CONTROL
DIMM	BEAM		MULTIPLE	ASSISTANCE
DALI DMX	SPOT MEDIUM FLOOD ASYMMETRIC		FEA- TURES	LONG-TERM SUPPORT

UPGRADES



ANTI-GLARE  
UNIT



CONNECT  
UNIT



WATER  
STOPPER



PIVOTABLE  
EXTERNAL



230 V DIRECT  
CONNECTION

## HIGHLY RESISTANT ARCHITECTURAL LIGHTING FOR

ARCHITECTURE  
COASTS  
HARBOURS  
FLOODED AREAS  
DIKES

...

BY WIBRE

AVAILABLE SOON



# LARC68

## THE ALL NEW VARIABLE INGROUND SPOTLIGHT

THESE INGROUND SPOTLIGHTS PROVIDES THE SAME HIGH DEGREE OF PROTECTION AS OUR WORLD FAMOUS UNDERWATER SPOTLIGHTS, ABOVE ALL IP68. HIGHLY RESISTANT AGAINST WATER AND SALTY AIR. THE SERIE ALSO IMPRESSES WITH ITS UNSURPASSED FLEXIBILITY.

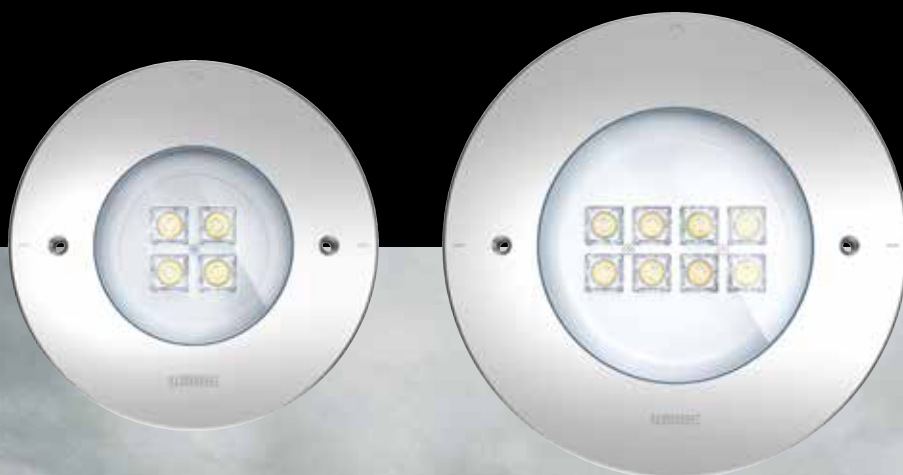

← LARC68: HIGHLY RESISTANT  
ARCHITECTURAL LIGHTING

THIS IS WIBRE →

# WIBRE

PIONEER, FAMILY-OWNED BUSINESS AND WORLD MARKET LEADER

The name WIBRE stands for the company founder Wilhelm BREuning. His pioneering work continues into the 4th generation. As a leading international family business, it is our highest claim to offer you first-class and durable quality spotlights. Manufactured in Germany. Developed for the world. Handmade for your project.







## ONE HUNDRED YEARS A SUCCESS STORY WITH A BRIGHT FUTURE

Only by constantly looking ahead can we write history.  
Since 1919 we have been developing and producing electrical devices of various kinds  
and since the 50s we have been producing luminaires for underwater use.  
20 years ago we started the development of LED spotlights.  
Back then and today, ground-breaking.

## LIGHT AND WATER ELEMENTS FOR OUR PASSION

Uniting the life elements water and light is what we strive for.  
We are passionate about developing waterproof light to perfection.  
The permanent function under water is our claim.  
Our aim: inspiring you with our light.

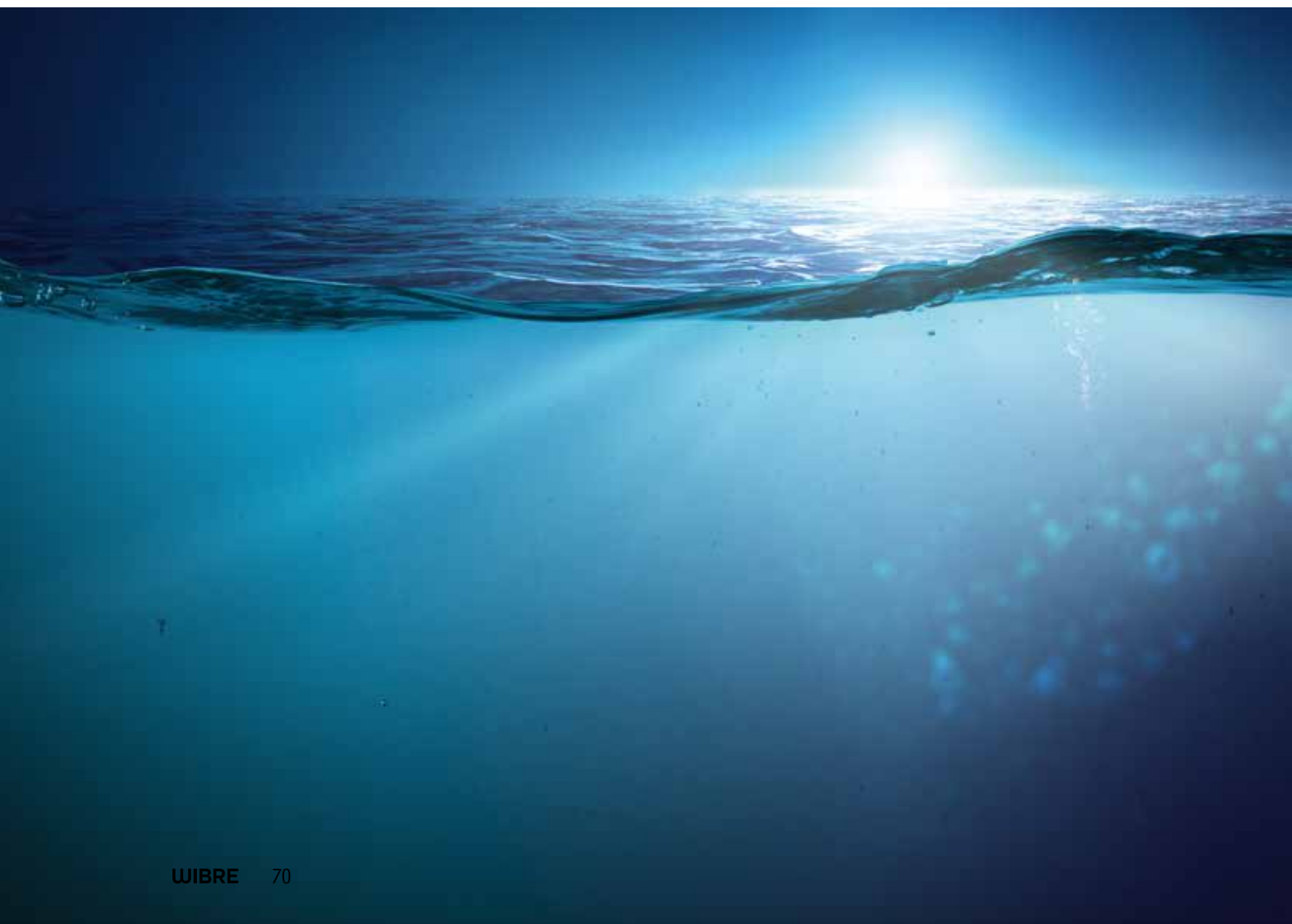



## STAINLESS STEEL

### THE MATERIAL OUR SPOTLIGHTS ARE MADE OF

The backbone for a long service life is our high-quality and carefully selected stainless steel protecting the inner life of the spotlight from all external influences, in the truest sense of the word. No plastic, no aluminium, no gunmetal.

Our specially treated V4A stainless steel for fresh water (1.4571) and salt water (1.4539) is corrosion-resistant and delivers what we promise: 10 years warranty.

\*Guarantee conditions can be found at [wibre.de/warranty](http://wibre.de/warranty).



## LIGHTING TECHNOLOGY

### OPTIMUM PERFORMANCE WITH LONG SERVICE LIFE

We aim at lighting each object in an optimal way.

This can only be achieved with powerful light and the right technology. Modular quality LED modules in variable light colours and RGB-W, combined with different optics guarantee customer-specific lighting. Each individual spotlight is adapted to the type of application in terms of luminous intensity and light spreading characteristics.

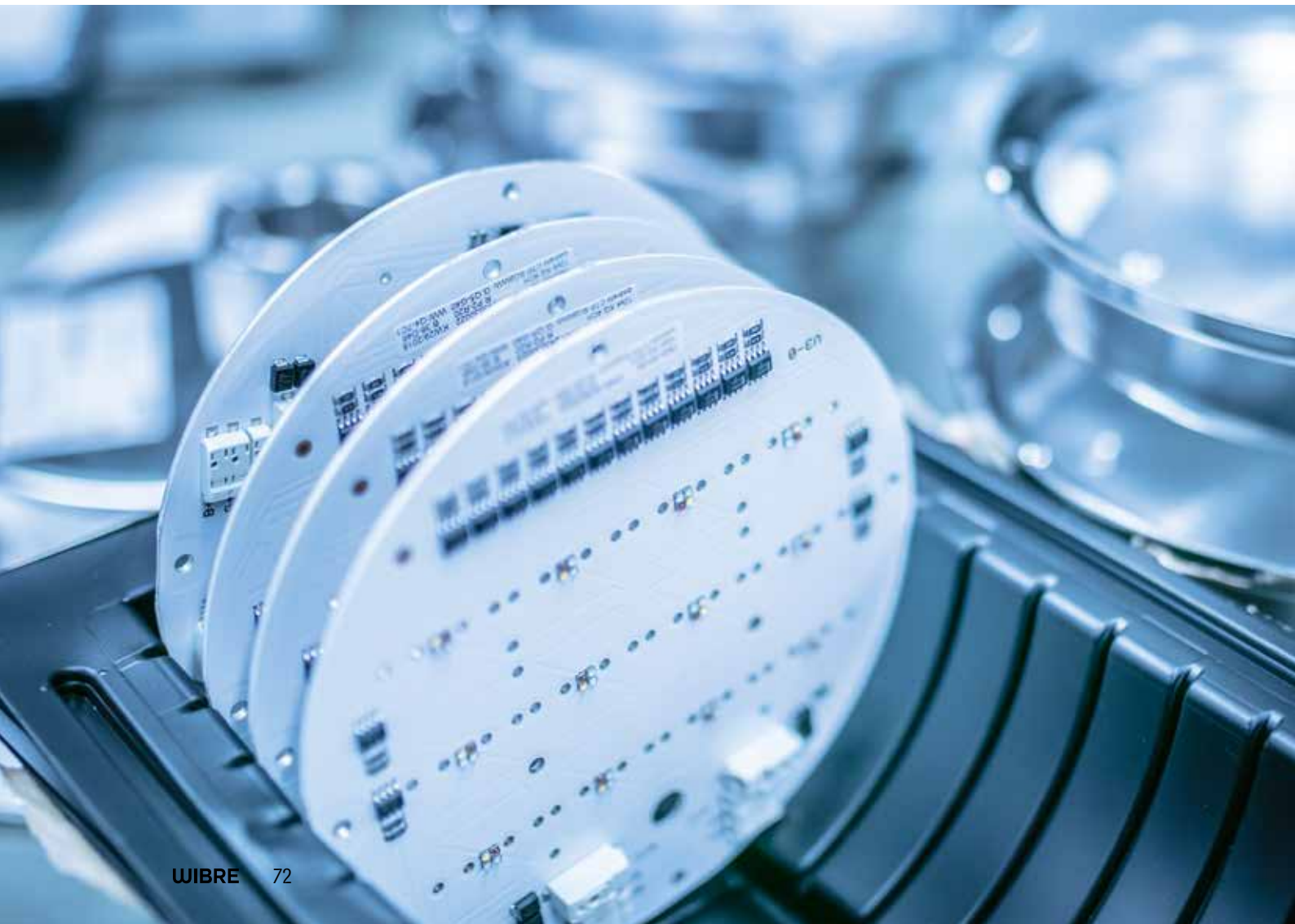



## GUARANTEED DURABILITY OUR PROMISE IN BLACK AND WHITE

No empty words and no fine print.

You receive a 10-year guarantee against rusting through on all installation pots and lamp housing made of stainless steel, as well as 5 years warranty on all spotlights of the CENTUM<sup>®</sup> series.

\*Guarantee conditions can be found at [wibre.de/warranty](http://wibre.de/warranty).



## CERTIFIED QUALITY CONSIDERED VERY GOOD

As a basis for the CENTUM<sup>®</sup> series, we have had tested the spotlight 4.0292 by an independent body. Without reservation, extraordinarily long service life and quality have been attested. And this applies to all our products.





## WITH CERTAINTY SAFE WITHOUT ANY ROUGH EDGES

No sharp edges, no sharp corners, no dangerous gap.  
All spotlights are geared to safety, both in design and electrical terms.  
Based on 12 V-DC low voltage, we meet the recommendation of the  
VDE standard for public bathing areas. For sure.



## CONTROLLED QUALITY

TRUST IS GOOD, CONTROL IS BETTER

Of course every single spotlight is individually checked from A to Z before it arrives at your premises. A 100 percent quality assurance is our promise to you. Trust us - we control.



**Imprint:**

Publisher: WIBRE Elektrogeräte Edmund Breuninger GmbH & Co.KG  
Liebigstr. 9, 74211 Leingarten/Germany  
Phone 07131 9053-0, Fax 07131 9053-19  
E-Mail: [info@wibre.de](mailto:info@wibre.de), Web: [www.wibre.de](http://www.wibre.de)

Edition: W969 Tools 20/21

Photos: WIBRE

Concept, text and design: Benjamin Pfendt (Wibre)

All information is not binding

Technical changes reserved

# LIGHT UP THE WORLD'S WATER.

1 HEADQUARTER

1 MANUFACTURING SITE

37 DISTRIBUTION PARTNERS

53 COUNTRIES





# CONTACT

CHOOSE THE PARTNER FOR YOUR COUNTRY:

[WWW.WIBRE.DE](http://WWW.WIBRE.DE)

OR SIMPLY CONTACT US DIRECTLY:

[INFO@WIBRE.DE](mailto:INFO@WIBRE.DE) · 0049 (0)7131 90530



**WIBRE**

PIONEERS IN  
IP68-LIGHTING